

# **USER MANUAL**

**SG-S156 / SG-S176 /  
SG-S216**

**15" / 17" / 21.5" Intel® 7th Gen. Core™ i5-7300U /  
Pentium 4415U Processor Fanless and All-around  
IP66/IP69K Stainless Panel PC**

**SG-S156 / SG-S176 / SG-S216 M2**

---

---

# ***SG-S156 / SG-S176 / SG-S216***

***15"/17"/21.5" Intel® 7th  
Core™ i5-7300U / Pentium 4415U  
Processor Fanless and All-around  
IP66/IP69K Stainless Panel PC***

## **COPYRIGHT NOTICE & TRADEMARK**

All trademarks and registered trademarks mentioned herein are the property of their respective owners.

This manual is copyrighted in Jan. 2020. You may not reproduce or transmit in any form or by any means, electronic, or mechanical, including photocopying and recording.

## **DISCLAIMER**

This user's manual is meant to assist users in installing and setting up the system. The information contained in this document is subject to change without any notice.

## **CE NOTICE**

This is a class A product. In a domestic environment this product may cause radio interference in which case the user may be required to take adequate measures.

---

---





---

---

**FCC NOTICE**

This equipment has been tested and found to comply with the limits for a Class A digital device, pursuant to part 15 of the FCC Rules. These limits are designed to provide reasonable protection against harmful interference when the equipment is operated in a commercial environment. This equipment generates, uses, and can radiate radio frequency energy and, if not installed and used in accordance with the instruction manual, may cause harmful interference to radio communications. Operation of this equipment in a residential area is likely to cause harmful interference in which case the user will be required to correct the interference at his own expense.

You are cautioned that any change or modifications to the equipment not expressly approve by the party responsible for compliance could void your authority to operate such equipment.

	<b>CAUTION:</b> Danger of explosion may occur when the battery is incorrectly replaced. Replace the battery only with the same or equivalent type recommended by the manufacturer. Dispose of used batteries according to the manufacturer's instructions.
	<b>CAUTION:</b> The waterproof capability of the device may be incapable when the screws are loosened.
	<b>CAUTION:</b> The O-ring to seal the device may be damaged during the maintenance process. Qualified engineer is recommended to make the O-ring replacement to keep the waterproof capability of the device.
	<b>WARNING:</b> Some internal parts of the system may have high electrical voltage. We strongly recommend that only qualified engineers are allowed to service and disassemble the system. If any damages should occur on the system and are caused by unauthorized servicing, it will not be covered by the product warranty.

---

---

---

---

# Contents

<b>1</b>	<b>Introduction .....</b>	<b>1-1</b>
1.1	About This Manual .....	1-2
<b>2</b>	<b>Getting Started .....</b>	<b>2-1</b>
2.1	Packing List.....	2-2
2.2	System Overview .....	2-3
2.3	SG-S156 / SG-S176 / SG-S216 System Specifications .....	2-9
2.4	Safety Precautions .....	2-11
<b>3</b>	<b>System Configuration.....</b>	<b>3-1</b>
3.1	External System I/O Ports Diagram .....	3-2
3.1.1	Rear I/O Ports Diagram .....	3-2
3.2	Jumper & Connector Quick Reference Table.....	3-3
3.3	Component Locations .....	3-4
3.3.1	Top View of BE-0996 .....	3-4
3.3.2	Bottom View of BE-0996 .....	3-5
3.4	How To Set Jumpers .....	3-6
3.5	Setting Main Board Connectors and Jumpers .....	3-8
3.5.1	COM2 Connector Pin9 Definition Selection Guide (JP_COM2).....	3-8
3.5.2	COM Connector (COM1, COM2) .....	3-9
3.5.3	Dual USB 3.0 Ports (USB1) .....	3-10
3.5.4	Dual USB 2.0 Ports (USB2, USB3).....	3-10
3.5.5	Internal USB 2.0 Connector (JUSB1).....	3-11
3.5.6	LAN1, LAN2 Ports (LAN1, LAN2).....	3-12
3.5.7	DP and HDMI Port (J1).....	3-13



---

3.5.8	Digital Input / Output Connector (JDIO1) .....	3-14
3.5.9	HD Audio Connector (AUDIO1).....	3-15
3.5.10	ATX Power Input Connector (ATX1).....	3-16
3.5.11	Speaker Connectors (SPK_L_OUT1, SPK_R_OUT1)....	3-17
3.5.12	Front Panel Connector (JFP1) .....	3-18
3.5.13	CPU Fan Connector (CPU_FAN1).....	3-18
3.5.14	SATA 3.0 Connector (SATA1).....	3-19
3.5.15	SATA Power Connector (JHDD_PWR1) .....	3-20
3.5.16	LVDS Connector (JLVDS1) .....	3-21
3.5.17	Panel Inverter Connector (JINV1) .....	3-22
3.5.18	Mini PCI Express Slot (M_PCIE1).....	3-23
3.5.19	mSATA Connector (M_SATA1).....	3-24
3.5.20	I2C Wafer (JI2C1).....	3-25
3.5.21	SPI Connector (JP7).....	3-25
3.5.22	SPI Override Protection Selection (JP1) .....	3-26
3.5.23	Battery Wafer (JBAT1).....	3-27
3.5.24	Slide Switch For LVDS Resolution Selection (SW1) .....	3-28
3.5.25	LVDS VCC Selection (JP5) .....	3-31
3.5.26	Backlight PWM Level Selection (JP6).....	3-32
3.5.27	V3P3 MPCIE Selection (JP9).....	3-33
3.5.28	Clear CMOS Data Selection (JCMOS1).....	3-34
3.6	External M12 Waterproof Connectors.....	3-35
3.6.1	USB 2.0 Connectors.....	3-35
3.6.2	Power Button .....	3-35
3.6.3	LAN1, LAN2 Ports .....	3-36
3.6.4	COM Connector.....	3-37
3.6.5	DC Power Input Connector .....	3-37
<b>4</b>	<b>Software Utilities .....</b>	<b>4-1</b>

---

4.1	Introduction.....	4-2
4.2	Installing Intel® Chipset Software Installation Utility .....	4-3
4.3	Installing Graphics Driver Utility .....	4-4
4.4	Installing Sound Driver Utility .....	4-5
4.5	Intel® Management Engine Components Driver Installer Installation .....	4-6
4.6	Installing LAN Driver Utility.....	4-7
4.7	Installing Intel® Serial I/O Driver Utility.....	4-8
<b>5</b>	<b>BIOS SETUP .....</b>	<b>5-1</b>
5.1	Introduction.....	5-2
5.2	Accessing Setup Utility.....	5-4
5.3	Main.....	5-7
5.4	Advanced .....	5-9
5.4.1	Advanced – CPU Configuration .....	5-10
5.4.2	Advanced – SATA Configuration .....	5-11
5.4.3	Advanced – PCH-FW Configuration.....	5-12
5.4.4	Advanced – Trusted Computing .....	5-13
5.4.5	Advanced – ACPI Settings .....	5-15
5.4.6	Advanced – F81866 Super IO Configuration .....	5-16
	F81866 Super IO Configuration – Serial Port 1 Configuration ....	5-17
	F81866 Super IO Configuration – Serial Port 2 Configuration ....	5-18
5.4.7	Advanced – Hardware Monitor.....	5-19
	Smart Fan Mode Configuration .....	5-20
5.4.8	Advanced – F81866 Watchdog .....	5-21
5.4.9	Advanced – S5 RTC Wake Settings.....	5-22
5.4.10	Advanced – USB Configuration.....	5-25
5.4.11	Advanced – Network Stack Configuration.....	5-26

---

5.5	Chipset .....	5-28
5.5.1	Chipset – System Agent (SA) Configuration .....	5-29
	System Agent (SA) Configuration – Memory Configuration .....	5-30
5.5.2	Chipset – PCH IO Configuratioin.....	5-31
	PCH-IO Configuration – PCI Express Configuration .....	5-32
5.6	Security .....	5-33
5.7	Boot .....	5-35
5.8	Save & Exit.....	5-36
 <b>Appendix A System Diagrams .....</b>		<b>A-1</b>
	SG-S156 System Exploded Diagram .....	A-2
	SG-S176 System Exploded Diagram .....	A-4
	SG-S216 System Exploded Diagram .....	A-6
	VESA Mount Installation Exploded Diagram .....	A-8
	Stand Kit Installation Exploded Diagram .....	A-9
	SG-S156 Packing Exploded Diagram .....	A-10
	SG-S176 Packing Exploded Diagram .....	A-11
	SG-S216 Packing Exploded Diagram .....	A-12
 <b>Appendix B Technical Summary .....</b>		<b>B-1</b>
	BE-0996 Block Diagram .....	B-2
	Interrupt Map .....	B-3
	I/O MAP .....	B-19
	Memory Map.....	B-21
	Configuring WatchDog Timer .....	B-24
	Flash BIOS Update.....	B-26

---

---

## Revision History

The revision history of SG-S156 / SG-S176 / SG-S216 User Manual is described below:

Version No.	Revision History	Date
M2	Added user manual information for SG-S176 and SG-S216.	2020/01/13
M1	Initial Release	2019/07/01

# 1 Introduction

---

This chapter provides the introduction for SG-S156 / SG-S176 / SG-S216 system as well as the framework of the user manual.

The following topic is included:

- About This Manual

## **1.1 About This Manual**

Thank you for purchasing our SG-S156 / SG-S176 / SG-S216 system. The SG-S156 / SG-S176 / SG-S216 provides faster processing speed, greater expandability and can handle more tasks than before. This manual is designed to assist you how to install and set up the whole system. It contains 5 chapters and 2 appendixes. Users can configure the system according to their own needs. This user manual is intended for service personnel with strong hardware background. It is not intended for general users.

The following section outlines the structure of this user manual.

### ***Chapter 1 Introduction***

This chapter provides the introduction for the SG-S156 / SG-S176 / SG-S216 system as well as the framework of the user manual.

### ***Chapter 2 Getting Started***

This chapter describes the package contents and outlines the system specifications. Read the safety reminders carefully on how to take care of your system properly.

### ***Chapter 3 System Configuration***

This chapter describes the external I/O ports, outlines the locations of the motherboard components and their respective functions. You will learn how to set the jumpers and configure the system to meet your own needs.

### ***Chapter 4 Software Utilities***

This chapter contains helpful information for proper installations of the Intel Chipset Software Installation Utility, Intel® Management Engine Components Driver Installer, Graphics Driver Utility, LAN Driver Utility, Sound Driver Utility and Intel® Serial I/O Driver Utility.

### ***Chapter 5 AMI BIOS Setup***

This chapter indicates you how to change the BIOS configurations.

### ***Appendix A System Diagrams***

This appendix provides exploded diagrams and part numbers of SG-S156 / SG-S176 / SG-S216 system.

### ***Appendix B Technical Summary***

This appendix provides the information about the allocation maps for the system resources, Watchdog Timer Configuration and Flash BIOS Update.

# 2 Getting Started

---

---

This chapter provides the information for the SG-S156 / SG-S176 / SG-S216 system. It describes the package contents and outlines the system specifications.

The following topics are included:

- Package List
- System Overview
- System Diagrams
- System Specification
- Safety Precautions

**Experienced users can go to Chapter 3 System Configuration on page 3-1 for a quick start.**

## 2.1 Packing List

If you discover any of the items listed above are damaged or lost, please contact your local distributor immediately.

Item	Q'ty
SG-S156 / SG-S176 / SG-S216	1
Quick Reference Guide	1
Manual / Driver DVD	1
M12 Power Supply Cable	1
U Stand (optional)	1



## 2.2 System Overview

Unit: mm

Front View

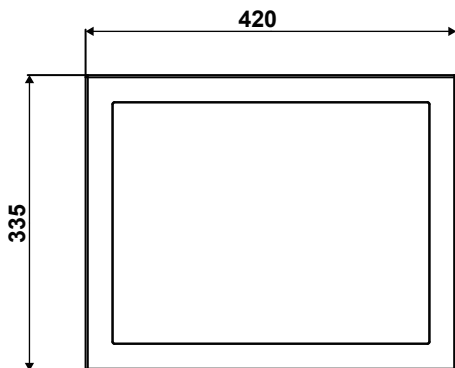

Rear View

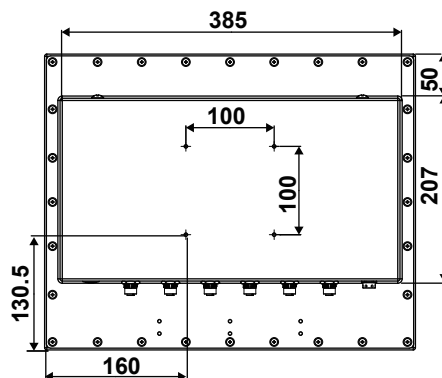

Top View

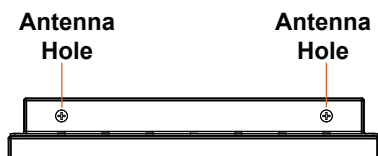

Bottom View

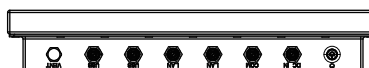

Left Side View

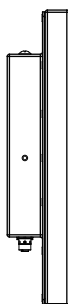

Right Side View



**Quarter View**

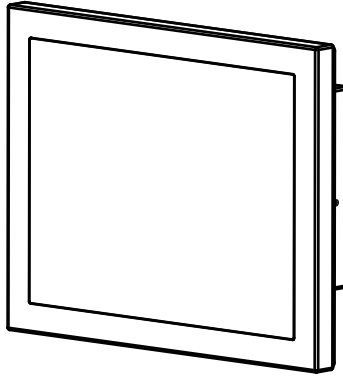

**SG-S176**

**Front View**

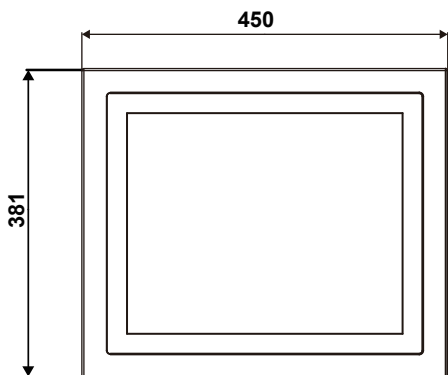

**Rear View**

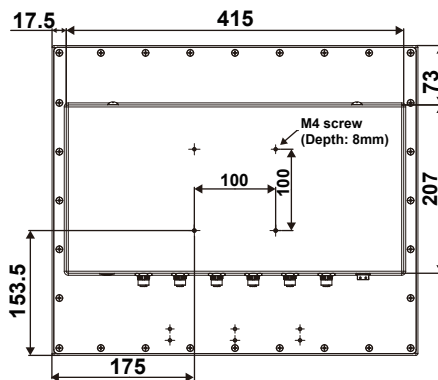

**Top View**

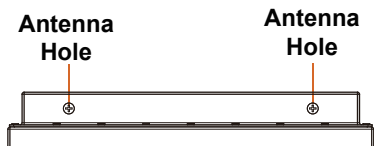

**Bottom View**

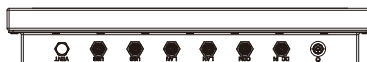

**Left Side View**

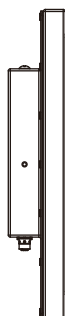

**Right Side View**



**Quarter View**

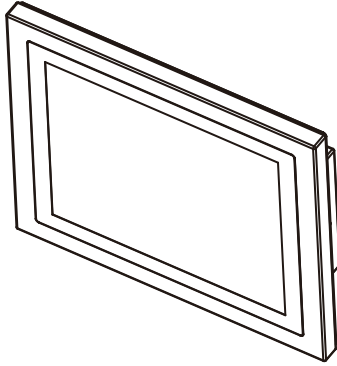

**SG-S216**

**Front View**

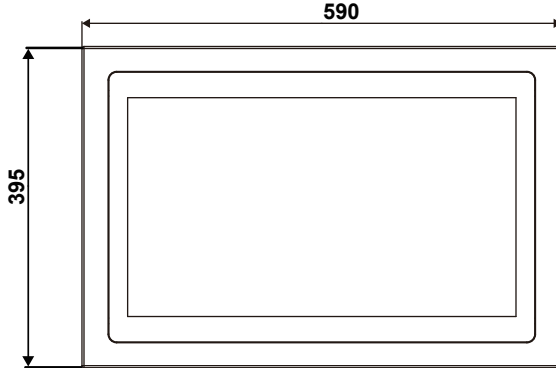

**Rear View**

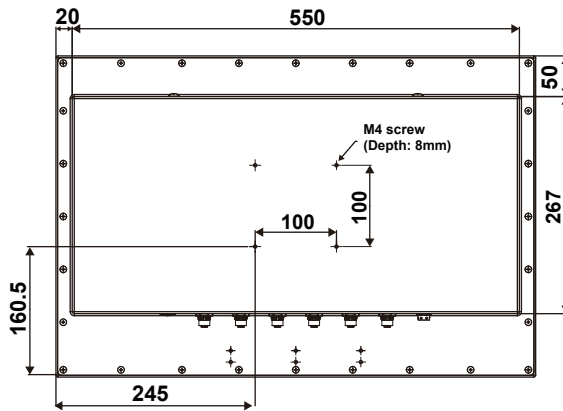

**Top View**

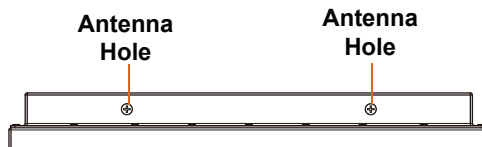

Bottom View

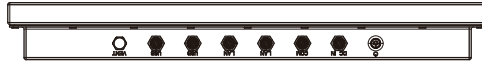

Left Side View



Right Side View



Quarter View

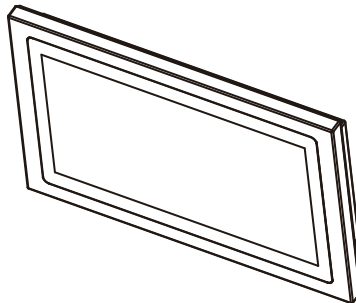

## 2.3 SG-S156 / SG-S176 / SG-S216 System Specifications

System	
CPU Type	<ul style="list-style-type: none"> <li>➤ Intel® 7th Gen. Core™ i5-7300U Processor</li> <li>➤ Intel® Pentium 4415U Processor</li> </ul>
Memory Support	<ul style="list-style-type: none"> <li>➤ 1 x DDR4 2133MHz SO-DIMM socket (up to 16GB) (non-ECC)</li> </ul>
Operating System	<ul style="list-style-type: none"> <li>➤ Windows® 10 IoT LTSC 2019</li> <li>➤ Ubuntu 16.04</li> </ul>
Enclosure	<ul style="list-style-type: none"> <li>➤ Stainless SUS304/SUS316</li> </ul>
IP Rating	<ul style="list-style-type: none"> <li>➤ IP66/IP69K</li> </ul>
Power Supply	<ul style="list-style-type: none"> <li>➤ DC In 12V/24V</li> </ul>
Mounting Support	<ul style="list-style-type: none"> <li>➤ Wall Mount / VESA 100 / Table Stand</li> </ul>
Watchdog	<ul style="list-style-type: none"> <li>➤ 1~255 second Watchdog timer selectable</li> </ul>
BIOS	<ul style="list-style-type: none"> <li>➤ AMI SPI BIOS</li> </ul>
Net Weight	<ul style="list-style-type: none"> <li>➤ <b>SG-S156:</b> 7.5kg</li> <li>➤ <b>SG-S176:</b> 8.5kg</li> <li>➤ <b>SG-S216:</b> 9.5kg</li> </ul>
Dimensions (W x H x D)	<ul style="list-style-type: none"> <li>➤ <b>SG-S156:</b> 420 x 335 x 70mm</li> <li>➤ <b>SG-S176:</b> 450 x 381 x 70mm</li> <li>➤ <b>SG-S216:</b> 590 x 395 x 70mm</li> </ul>
Certifications	<ul style="list-style-type: none"> <li>➤ FCC / CE</li> </ul>
I/O Ports	
Power Input	<ul style="list-style-type: none"> <li>➤ 1 x M12 Waterproof Connector with Remote Switch</li> <li>➤ Supports 12V, 24V DC</li> </ul>
Serial Port	<ul style="list-style-type: none"> <li>➤ 1 x COM port with M12 waterproof connector</li> <li>➤ COM1 for RS-232/422/485 selectable under BIOS</li> </ul>
LAN	<ul style="list-style-type: none"> <li>➤ 2 x GbE LANs with M12 waterproof connectors</li> <li>LAN 1: Intel® I210IT</li> <li>LAN 2: Intel® I210IT</li> <li>➤ Supports Wake-On-LAN</li> </ul>
USB	<ul style="list-style-type: none"> <li>➤ 2 x USB 2.0 M12 waterproof connectors</li> </ul>
Storage	<ul style="list-style-type: none"> <li>➤ 1 x 2.5" SATA III HDD or SSD</li> </ul>
Expansion Slot	<ul style="list-style-type: none"> <li>➤ 1 x full-sized Mini PCIe slot (Mini PCIe and USB signals)</li> </ul>

Display	
LCD	<ul style="list-style-type: none"> <li>➤ <b>SG-S156:</b> 15" TFT LCD (LED) XGA (1024 x 768), 450 nits</li> <li>➤ <b>SG-S176:</b> 17" TFT LCD (LED) XGA (1280 x 1024), 350 nits</li> <li>➤ <b>SG-S216:</b> 21.5" TFT LCD (LED) FHD (1920 x 1080), 350 nits</li> </ul>
Touchscreen	➤ Projected capacitive or 5-wire resistive touchscreen (USB interface)
Environment	
Operating Temperature (with airflow)	<ul style="list-style-type: none"> <li>➤ HDD: 0°C ~ 40°C (32°F ~ 104°F)</li> <li>➤ SSD: 0°C ~ 50°C (32°F ~ 122°F)</li> </ul>
Storage Temperature	➤ -20°C ~ 80°C (-4°F ~ 176°F)
Humidity	➤ 20%~ 90%



## **2.4 Safety Precautions**

Before operating this system, read the following information carefully to protect your systems from damages, and extend the life cycle of the system.

### **1. Check the Line Voltage**

- The operating voltage for the power supply should be DC IN 12V/24V; otherwise, the system may be damaged.

### **2. Environmental Conditions**

- Place your SG-S156 / SG-S176 / SG-S216 on a sturdy, level surface. Be sure to allow enough space around the system to have easy access needs.
- Avoid installing your SG-S156 / SG-S176 / SG-S216 system in extremely hot or cold places.
- Avoid direct sunlight exposure for a long period of time (for example, in a closed car in summer time. Also avoid the system from any heating device.). Or do not use SG-S156 / SG-S176 / SG-S216 when it has been left outdoors in a cold winter day.
- Avoid moving the system rapidly from a hot place to a cold place, and vice versa, because condensation may occur inside the system.
- Protect your SG-S156 / SG-S176 / SG-S216 from strong vibrations which may cause hard disk failure.
- Do not place the system too close to any radio-active device. Radio-active device may cause signal interference.
- Always shut down the operating system before turning off the power.

### **3. Handling**

- Avoid placing heavy objects on the top of the system.
- Do not turn the system upside down. This may cause the hard drive to malfunction.
- Do not allow any objects to fall into this device.

### **4. Good Care**

- When the outside case gets stained, remove the stains using neutral washing agent with a dry cloth.
- Never use strong agents such as benzene and thinner to clean the surface of the case.
- If heavy stains are present, moisten a cloth with diluted neutral washing agent or alcohol and then wipe thoroughly with a dry cloth.
- If dust is accumulated on the case surface, remove it by using a special vacuum cleaner for computers.

# 3 System Configuration

---

---

This chapter contains helpful information about the external I/O Ports diagram, and jumper & connector settings, and component locations for the main board.

The following topics are included:

- External I/O Ports Diagrams
- Main Board Component Locations
- How to Set Jumpers
- Setting Main Board Connectors and Jumpers

### 3.1 External System I/O Ports Diagram

#### 3.1.1 Rear I/O Ports Diagram

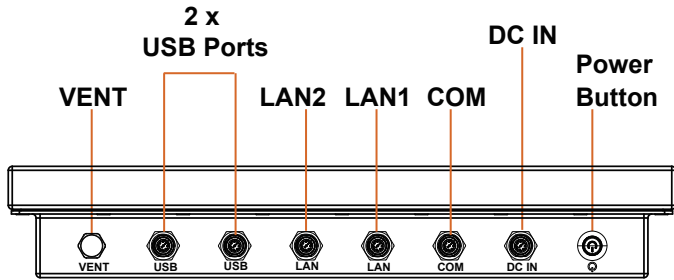

### 3.2 Jumper & Connector Quick Reference Table

<b>JUMPER Description</b>	<b>NAME</b>
COM2 Pin9 RI/5V/12V Selection	JP_COM2
Clear CMOS Data Selection	JCMOS1
SPI Override Protection Selection	JP1
LVDS VCC Selection	JP5
Backlight PWM Level Selection	JP6
V3P3 MPCIE Selection	JP9
Slide Switch For LVDS Resolution Selection	SW1

<b>CONNECTOR Description</b>	<b>NAME</b>
COM Connectors (Onboard Pin Header)	COM1, COM2
Dual USB 2.0 Ports (rear I/O)	USB2, USB3
Dual USB 3.0 Ports (rear I/O)	USB1
2 x LAN Ports (rear I/O)	LAN1, LAN2
Internal USB 2.0 Connector	JUSB1
DP and HDMI Port (rear I/O)	J1
HD Audio Connector	AUDIO1
ATX Power Input Connector	ATX1
Speaker Connectors	SPK_L_OUT1, SPK_R_OUT1
Digital Input / Output Connector	JDIO1
Front Panel Connector	JFP1
CPU Fan Connector	CPU_FAN1
SATA 3.0 Connector	SATA1
SATA Power Connector	JHDD_PWR1
LVDS Connector	JLVDS1
Panel Inverter Connector	JINV1
Mini PCI Express Slot	M_PCIE1
mSATA Connector	M_SATA1
I2C Wafer	JI2C1
Battery Wafer	JBAT1
SPI Connector	JP7
DDR4 SO-DIMM Memory Socket 1	DIMM1



3.3.2 Bottom View of BE-0996

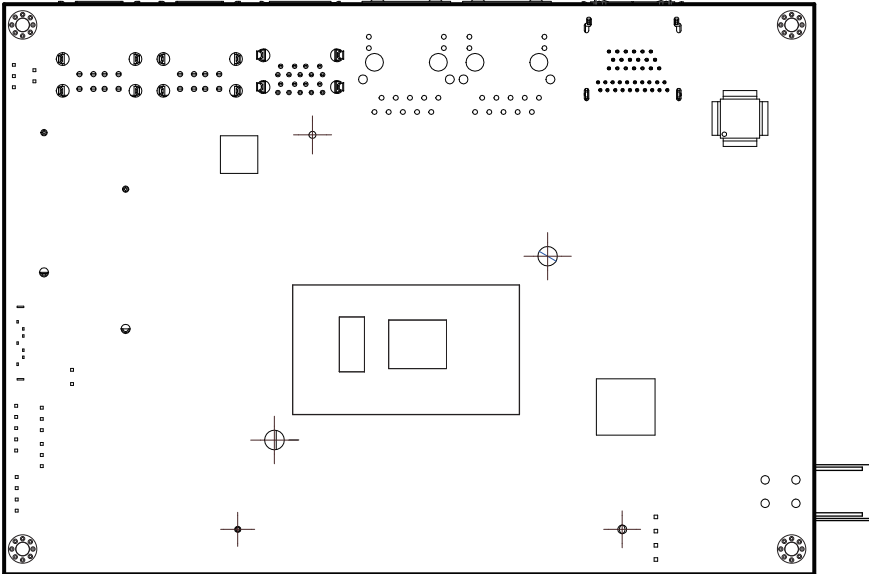

### 3.4 How To Set Jumpers

You can configure your board by setting jumpers. Jumper is consists of two or three metal pins with a plastic base mounted on the card, and by using a small plastic "cap", Also known as the jumper cap (with a metal contact inside), you are able to connect the pins. So you can set-up your hardware configuration by "open" or "close" pins.

The jumper can be combined into sets that called jumper blocks. When the jumpers are all in the block, you have to put them together to set up the hardware configuration. The figure below shows how this looks like.

#### JUMPERS AND CAPS

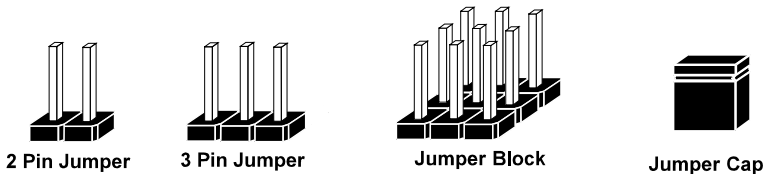

If a jumper has three pins (for examples, labelled PIN1, PIN2, and PIN3), you can connect PIN1 & PIN2 to create one setting by shorting. You can either connect PIN2 & PIN3 to create another setting. The same jumper diagrams are applied all through this manual. The figure below shows what the manual diagrams look and what they represent.

## Jumper Diagrams



Jumper Cap  
looks like this

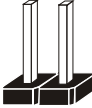

2 pin Jumper  
looks like this

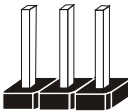

3 pin Jumper  
looks like this

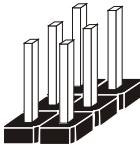

Jumper Block  
looks like this

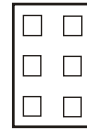

## Jumper Settings



2 pin Jumper close(enabled)  
Looks like this

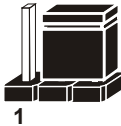

3 pin Jumper  
2-3 pin close(enabled)  
Looks like this



Jumper Block  
1-2 pin close(enabled)  
Looks like this

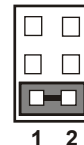



### 3.5 Setting Main Board Connectors and Jumpers

#### 3.5.1 COM2 Connector Pin9 Definition Selection Guide (JP\_COM2)

Jumper Location: JP\_COM2

Description: COM2 Connector pin9 RI/+5V/+12V Selection

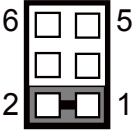
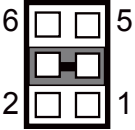
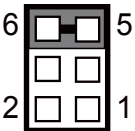
SELECTION	JUMPER SETTING	JUMPER ILLUSTRATION
RI	1-2 <i>(Default Setting)</i>	 <p><b>JP_COM2</b></p>
12V	3-4	 <p><b>JP_COM2</b></p>
5V	5-6	 <p><b>JP_COM2</b></p>

### 3.5.2 COM Connector (COM1, COM2)

#### Connector Location: COM1

**Description:** COM1 (RS-232) Connector (onboard pin header)

#### COM1 Connector Pin Assignment:

PIN	ASSIGNMENT	PIN	ASSIGNMENT
1	DCD#	6	DSR#
2	RX	7	RTS#
3	TX	8	CTS#
4	DTR#	9	RI#
5	GND	-	-

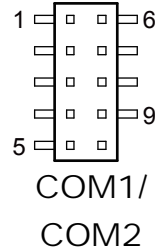

#### Connector Location: COM2

**Description:** COM2 Connector (onboard pin header)

COM2 is RS-232/422/485 selectable under BIOS.

#### COM2 Connector Pin Assignment:

PIN	ASSIGNMENT		
	RS-232	RS-422	RS-485
1	DCD#	TX-	RS-485-
2	RX	TX+	RS-485+
3	TX	RX+	NC
4	DTR#	RX-	NC
5	GND	GND	GND
6	DSR#	NC	NC
7	RTS#	NC	NC
8	CTS#	NC	NC
9	RI#	NC	NC

**Note:**

**COM2:** Pin 9 is selectable for RI, +5V or +12V by **JP\_COM2** jumper setting. Default setting is RI. Please see “**COM2 PIN9 Definition Selection Guide**” for selection details.

### 3.5.3 Dual USB 3.0 Ports (USB1)

**Port Location:** USB1 (rear I/O)

**Description:** Dual USB 3.0 Port

**USB 3.0 connector signals:**

PIN	ASSIGNMENT	PIN	ASSIGNMENT
A1	5V	A9	TX1_DP
A2	USBP1N	A8	TX1_DN
A3	USBP1P	A7	GND
A4	GND	A6	RX1_DP
-	-	A5	RX1_DN
B1	5V	B9	TX2_DP
B2	USBP2N	B8	TX2_DN
B3	USBP2P	B7	GND
B4	GND	B6	RX2_DP
-	-	B5	RX2_DN

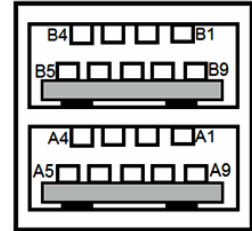

USB1

### 3.5.4 Dual USB 2.0 Ports (USB2, USB3)

**Port Location:** USB2, USB3 (rear I/O)

**Description:** Dual USB 2.0 Ports (Type A)

**USB 2.0 connector signals:**

PIN	ASSIGNMENT	PIN	ASSIGNMENT
1	+5V	5	+5V
2	USBP3N	6	USBP4N
3	USBP3P	7	USBP4P
4	GND	8	GND

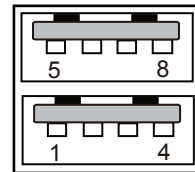

USB2/  
USB3

### 3.5.5 Internal USB 2.0 Connector (JUSB1)

**Connector Location:** JUSB1

**Description:** Internal USB 2.0 Connector

**USB 2.0 connector signals:**

PIN	ASSIGNMENT	PIN	ASSIGNMENT
1	+5V	2	+5V
3	USBP7N	4	USBP10N
5	USBP7P	6	USBP10P
7	GND	8	GND
9	GND	10	GND

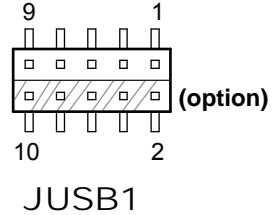

**Note:** The functions of **JUSB1** option pins are only supported on Core-i5 / i3 SoC boards.

### 3.5.6 LAN1, LAN2 Ports (LAN1, LAN2)

**Port Location:** LAN1, LAN2 (rear I/O)

**Description:** LAN1 & LAN2 Ports

**LAN1, LAN2 signals:**

PIN	ASSIGNMENT
1	MDI_0P
2	MDI_0N
3	MDI_1P
4	MDI_2P
5	MDI_2N
6	MDI_1N
7	MDI_3P
8	MDI_3N

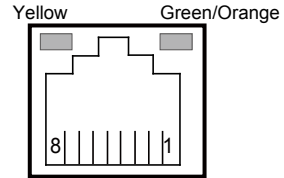

LAN1/  
LAN2

**LAN LED Indicator:**

**Right Side LED**

Green Color On	10/100Mbps LAN Speed Indicator
Orange Color On	Giga LAN Speed Indicator
Off	No LAN switch/hub connected

**Left Side LED**

Yellow Color Blinking	LAN Message Active
Off	No LAN Message Active

### 3.5.7 DP and HDMI Port (J1)

**Port Location: J1** (rear I/O)

**Description:** DisplayPort Connector (top side) and HDMI Connector (bottom side)

Pin Assignment for DisplayPort Connector:

PIN	ASSIGNMENT	PIN	ASSIGNMENT
P1	DP_C_DATA0+	P2	GND
P3	DP_C_DATA0-	P4	DP_C_DATA1+
P5	GND	P6	DP_C_DATA1-
P7	DP_C_DATA2+	P8	GND
P9	DP_C_DATA2-	P10	DP_C_DATA3+
P11	GND	P12	DP_C_DATA3-
P13	DP_C_AUX_ENJ	P14	GND
P15	DP_C_AUX+	P16	GND
P17	DP_C_AUX-	P18	HPD
P19	GND	P20	DP_VCC3_3

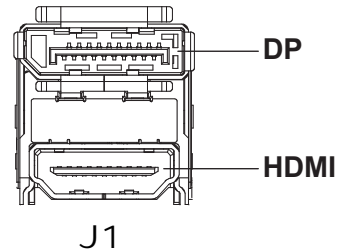

Pin Assignment for HDMI Port Connector:

PIN	ASSIGNMENT	PIN	ASSIGNMENT
1	DP0_HDMI_P2	2	GND
3	DP0_HDMI_N2	4	DP0_HDMI_P1
5	GND	6	DP0_HDMI_N1
7	DP0_HDMI_P0	8	GND
9	DP0_HDMI_N0	10	DP0_HDMI_CLKP
11	GND	12	DP0_HDMI_CLKN
13	NC	14	NC
15	DP0_HDMI_SCL	16	DP0_HDMI_SDA
17	GND	18	VCC5_HDMI
19	DP0_HDMI_HPD_IN	-	-

### 3.5.8 Digital Input / Output Connector (JDIO1)

Connector Location: JDIO1

Description: Digital Input / Output Connector

PIN	ASSIGNMENT	PIN	ASSIGNMENT
1	5V	2	5V
3	GND	4	GND
5	DIN_0	6	DOUT_0
7	DIN_1	8	DOUT_1
9	DIN_2	10	DOUT_2
11	DIN_3	12	DOUT_3
13	DIN_4	14	DOUT_4
15	DIN_5	16	DOUT_5
17	DIN_6	18	DOUT_6
19	DIN_7	20	DOUT_7

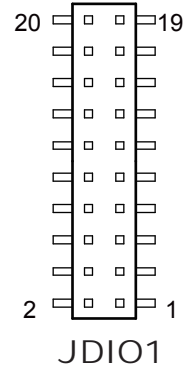

### 3.5.9 HD Audio Connector (AUDIO1)

Connector Location: AUDIO1

Description: HD Audio Connector for Line In/Line Out/Mic In.

PIN	ASSIGNMENT	PIN	ASSIGNMENT
1	MIC1-L	2	MIC1-R
3	GND	4	GND
5	HD_LINE-IN-L_L	6	HD_LINE-IN-R_L
7	GND	8	GND
9	LINE-OUT-L	10	LINE-OUT-R

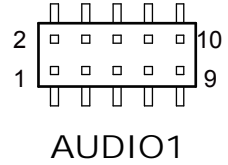



### 3.5.10 ATX Power Input Connector (ATX1)

Connector Location: ATX1

Description: ATX Power Input Connector

PIN	ASSIGNMENT	PIN	ASSIGNMENT
1	GND	3	+12V / +24V
2	GND	4	+12V / +24V

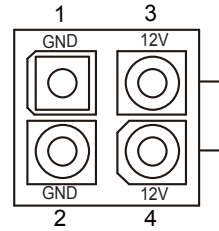

ATX1

### 3.5.11 Speaker Connectors (SPK\_L\_OUT1, SPK\_R\_OUT1)

Connector Location: SPK\_L\_OUT1

Description: Speaker Out Connector (Left side)

PIN	ASSIGNMENT
1	AMP_OUTL+
2	AMP_OUTL-

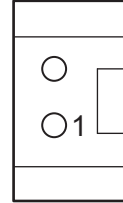

SPK\_L\_OUT1

Connector Location: SPK\_R\_OUT1

Description: Speaker Out Connector (Right side)

PIN	ASSIGNMENT
1	AMP_OUTR+
2	AMP_OUTR-

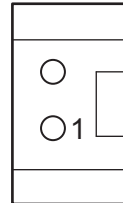

SPK\_R\_OUT1

### 3.5.12 Front Panel Connector (JFP1)

Connector Location: JFP1

Description: Front Panel Connector

PIN	ASSIGNMENT	PIN	ASSIGNMENT
1	HDD LED+	2	PWR LED+
3	HDD LED-	4	PWR LED-
5	GND	6	Power Button
7	Reset Button	8	GND
9	5V	-	-

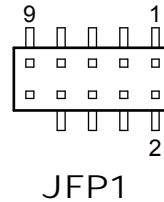

### 3.5.13 CPU Fan Connector (CPU\_FAN1)

Connector Location: CPU\_FAN1

Description: CPU Fan Connector

CPU Fan Connector signals:

PIN	ASSIGNMENT
1	GND
2	VCC12
3	TAC
4	CTL

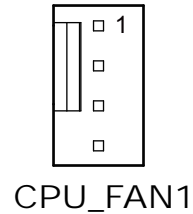

**3.5.14 SATA 3.0 Connector (SATA1)**

**Connector Location: SATA1**

**Description:** Serial ATA (SATA) 6GB/s Connector



**SATA1**

**Serial ATA 6GB/s Connector (SATA1) signals:**

PIN	ASSIGNMENT
1	GND
2	TXPC
3	TXNC
4	GND
5	RXNC
6	RXPC
7	GND

### 3.5.15 SATA Power Connector (JHDD\_PWR1)

Connector Location: JHDD\_PWR1

Description: Serial ATA Power Connector

SATA Power Connector signals:

PIN	ASSIGNMENT
1	5V
2	GND

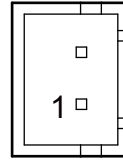

JHDD\_PWR1

### 3.5.16 LVDS Connector (JLVDS1)

Connector Location: JLVDS1

Description: LVDS Connector

PIN	ASSIGNMENT	PIN	ASSIGNMENT
1	+3.3V/+5V	2	GND
3	LVDS_CLKBM	4	LVDS_CLKBP
5	GND	6	LVDS_YBM2
7	LVDS_YBP2	8	GND
9	LVDS_YBM1	10	LVDS_YBP1
11	LVDS_YBP3	12	LVDS_YBM3
13	LVDS_YBP0	14	LVDS_YBM0
15	GND	16	LVDS_CLKAP
17	LVDS_CLKAM	18	GND
19	LVDS_YAP2	20	LVDS_YAM2
21	GND	22	LVDS_YAP1
23	LVDS_YAM1	24	GND
25	LVDS_YAP0	26	LVDS_YAM0
27	LVDS_YAP3	28	LVDS_YAM3
29	+3.3V/+5V	30	+3.3V/+5V

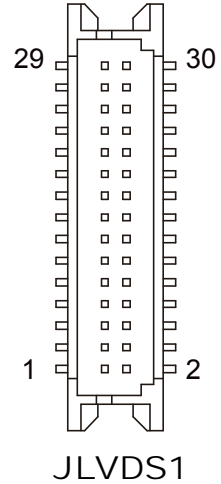

### 3.5.17 Panel Inverter Connector (JINV1)

Connector Location: JINV1

Description: Panel Inverter Connector

PIN	ASSIGNMENT
1	+12V
2	GND
3	Backlight PWM
4	GND
5	Backlight Enable

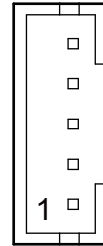

JINV1

**3.5.18 Mini PCI Express Slot (M\_PCIE1)**

**Connector Location:** M\_PCIE1

**Description:** Mini-PCI Express Slot

Mini-PCI Express Slot (M\_PCIE1) signals:

PIN	ASSIGNMENT	PIN	ASSIGNMENT
1	WAKEJ	2	VCC3_3_SB
3	NC	4	GND
5	NC	6	VCC1_5
7	CLKREQJ	8	NC
9	GND	10	NC
11	CLK_DN	12	NC
13	CLK_DP	14	NC
15	GND	16	NC
17	NC	18	GND
19	NC	20	NC
21	GND	22	PLTRSTJ_BUF
23	PCIE_RXN	24	VCC3_3_SB
25	PCIE_RXP	26	GND
27	GND	28	VCC1_5
29	GND	30	SMB_CLK
31	PCIE_TXN	32	SMB_DATA
33	PCIE_TXP	34	GND
35	GND	36	USBN
37	GND	38	USBP
39	VCC3_3_SB	40	GND
41	VCC3_3_SB	42	NC
43	GND	44	NC
45	NC	46	NC
47	NC	48	VCC1_5
49	NC	50	GND
51	NC	52	VCC3_3_SB

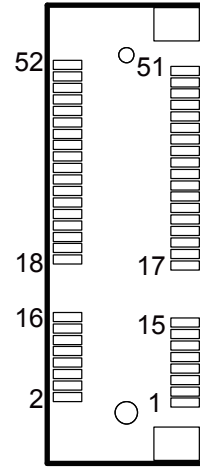

M\_PCIE1

**Mini PCI Express** is the successor of the Mini PCI card and provides an increased data throughput. The cards have a detached network interface and are equipped with one lane. They are used in particular in embedded designs or compact box PCs.



### 3.5.19 mSATA Connector (M\_SATA1)

Connector Location: M\_SATA1

Description: mSATA Slot

PIN	ASSIGNMENT	PIN	ASSIGNMENT
1	NC	2	3.3V
3	NC	4	GND
5	NC	6	NC
7	NC	8	NC
9	GND	10	NC
11	NC	12	NC
13	NC	14	NC
15	GND	16	NC
17	NC	18	GND
19	NC	20	NC
21	GND	22	NC
23	mSATA1_RX_DP	24	3.3V
25	mSATA1_RX_DN	26	GND
27	GND	28	NC
29	GND	30	NC
31	mSATA1_TX_DN	32	NC
33	mSATA1_TX_DP	34	GND
35	GND	36	USB2_P9_DN
37	GND	38	USB2_P9_DP
39	3.3V	40	GND
41	3.3V	42	NC
43	NC	44	NC
45	NC	46	NC
47	NC	48	NC
49	NC	50	GND
51	NC	52	3.3V

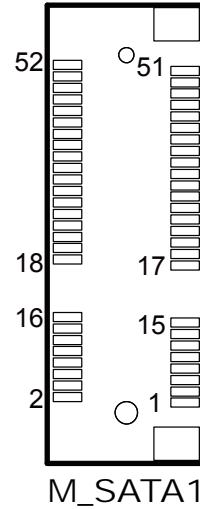

**Note:** The USB function is only supported on Core-i5 / i3 SoC boards.

### 3.5.20 I2C Wafer (J12C1)

Connector Location: J12C1

Description: I2C Wafer

PIN	ASSIGNMENT
1	5V
2	GND
3	I2C0_SCL
4	I2C0_SDA

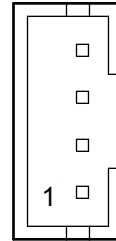

J12C1

### 3.5.21 SPI Connector (JP7)

Connector Location: JP7

Description: SPI Connector

PIN	ASSIGNMENT	PIN	ASSIGNMENT
1	3.3V	2	GND
3	CSJ	4	CLK
5	MISO	6	MOSI
7	NC	8	NC

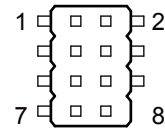



JP7

**3.5.22 SPI Override Protection Selection (JP1)**

**Jumper Location: JP1**

**Description:** SPI Override Protection Selection

SELECTION	JUMPER SETTING	JUMPER ILLUSTRATION
Disable	<i>Open (Default Setting)</i>	 <b>JP1</b>
Enable	Close	 <b>JP1</b>

### 3.5.23 Battery Wafer (JBAT1)

Connector Location: JBAT1

Description: Battery Wafer

PIN	ASSIGNMENT
1	VBAT+
2	GND

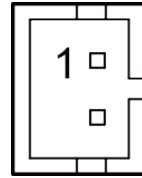

**JBAT1**

**3.5.24 Slide Switch For LVDS Resolution Selection (SW1)**

**Jumper Location: SW1**

**Description: LVDS Resolution/Channel/Color Bit Selection**

SELECTION	SW1	PIN	SETTING
1024 x 768 Channel S/8bit (for SG-S156)		1-8	ON
		2-7	OFF
		3-6	ON
		4-5	ON
800 x 600 Channel S/6bit		1-8	ON
		2-7	ON
		3-6	ON
		4-5	ON
1024 x 768 Channel S/6bit		1-8	OFF
		2-7	ON
		3-6	ON
		4-5	ON
1280 x 768 Channel S/6bit		1-8	OFF
		2-7	OFF
		3-6	ON
		4-5	ON
1280 x 800 Channel S/6bit		1-8	ON
		2-7	ON
		3-6	OFF
		4-5	ON

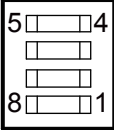
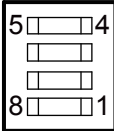
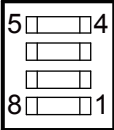
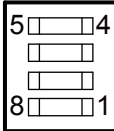
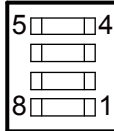
SELECTION	SW1	PIN	SETTING
1280 x 960 Channel S/6bit		1-8	OFF
		2-7	ON
		3-6	OFF
		4-5	ON
<b>1280 x 1024 Channel D/8bit (for SG-S176)</b>		<b>1-8</b>	<b>ON</b>
		<b>2-7</b>	<b>OFF</b>
		<b>3-6</b>	<b>OFF</b>
		<b>4-5</b>	<b>ON</b>
1366 x 768 Channel S/6bit		1-8	OFF
		2-7	OFF
		3-6	OFF
		4-5	ON
1366 x 768 Channel S/8bit		1-8	ON
		2-7	ON
		3-6	ON
		4-5	OFF
1440 x 900 Channel D/8bit		1-8	OFF
		2-7	ON
		3-6	ON
		4-5	OFF

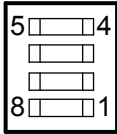
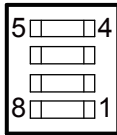
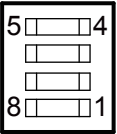
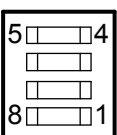
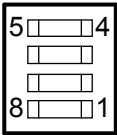
SELECTION	SW1	PIN	SETTING
1400 x 1050 Channel D/8bit		1-8	ON
		2-7	OFF
		3-6	ON
		4-5	OFF
1600 x 900 Channel D/8bit		1-8	OFF
		2-7	OFF
		3-6	ON
		4-5	OFF
1680 x 1050 Channel D/8bit		1-8	ON
		2-7	ON
		3-6	OFF
		4-5	OFF
1600 x 1200 Channel D/8bit		1-8	OFF
		2-7	ON
		3-6	OFF
		4-5	OFF
<b>1920 x 1080</b> <b>Channel D/8bit</b> <i>(for SG-S216)</i>		<b>1-8</b>	<b>ON</b>
		<b>2-7</b>	<b>OFF</b>
		<b>3-6</b>	<b>OFF</b>
		<b>4-5</b>	<b>OFF</b>

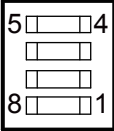
SELECTION	SW1	PIN	SETTING
1920 x 1200 Channel D/8bit		1-8	OFF
		2-7	OFF
		3-6	OFF
		4-5	OFF

### 3.5.25 LVDS VCC Selection (JP5)

Jumper Location: JP5

Description: LVDS VCC Selection

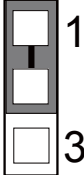
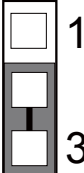
SELECTION	JUMPER SETTING	JUMPER ILLUSTRATION
3.3V	1-2 (SG-S156 Default)	 <p><b>JP5</b></p>
5V	2-3 (SG-S176 & SG-S216 Default)	 <p><b>JP5</b></p>



**3.5.26 Backlight PWM Level Selection (JP6)**

**Jumper Location:** JP6

**Description:** Backlight PWM Level Selection

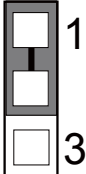
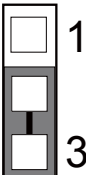
SELECTION	JUMPER SETTING	JUMPER ILLUSTRATION
3.3V	<i>1-2 (Default Setting)</i>	 <p><b>JP6</b></p>
5V	2-3	 <p><b>JP6</b></p>

### 3.5.27 V3P3 MPCIE Selection (JP9)

Jumper Location: JP9

Description: V3P3 MPCIE Selection

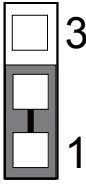
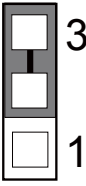
SELECTION	JUMPER SETTING	JUMPER ILLUSTRATION
VCC3_3	<i>1-2 (Default Setting)</i>	 <p><b>JP9</b></p>
V3P3A	2-3	 <p><b>JP9</b></p>

**3.5.28 Clear CMOS Data Selection (JCMOS1)**

**Jumper Location: JCMOS1**

**Description:** Clear CMOS Data Selection

- Step 1.** Remove the main power of the PC.
- Step 2.** Close **JCMOS1** (pins 1-2) for 6 seconds by a cap.
- Step 3.** Remove the cap which is just used on **JCMOS1** (1-2), so that **JCMOS1** returns to “OPEN”.
- Step 4.** Power on the PC and the PC will then auto-reboot for once in order to set SoC’s register.
- Step 5.** Done!

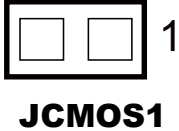
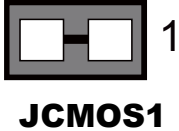
SELECTION	JUMPER SETTINGS	JUMPER ILLUSTRATION
Normal	<i>Open (Default Setting)</i>	 <p><b>JCMOS1</b></p>
Clear CMOS Data	Close	 <p><b>JCMOS1</b></p>

**Note:** Please make sure the main power is off before you clear CMOS.

### 3.6 External M12 Waterproof Connectors

#### 3.6.1 USB 2.0 Connectors

Connector Location: **USB 2.0**

Description: External USB 2.0 connectors

Pin Assignment:

PIN	ASSIGNMENT
1	USB0_VCC5
2	USB0_P1_DN
3	USB0_P2_DP
4	USB0_GND
5	USB1_VCC5
6	USB1_P1_DN
7	USB1_P2_DP
8	USB1_GND

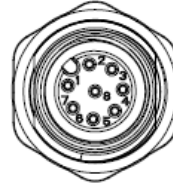

**USB 2.0**

#### 3.6.2 Power Button

Location: **Power Button**

Description: Power Button

PIN	ASSIGNMENT
1	Power BTN
2	Power LED +
3	GND
4	GND



**Power Button**

**3.6.3 LAN1, LAN2 Ports**

**Port Location: LAN1, LAN2**

**Description: LAN1, LAN2 Port**

**LAN1 Pin Assignment:**

PIN	ASSIGNMENT
1	LAN1_MDIP0
2	LAN1_MDIN0
3	LAN1_MDIP1
4	LAN1_MDIP2
5	LAN1_MDIN2
6	LAN1_MDIN1
7	LAN1_MDIP3
8	LAN1_MDIN3

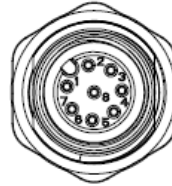

**LAN1 / LAN2**

**LAN2 Pin Assignment:**

PIN	ASSIGNMENT
1	LAN2_MDIP0
2	LAN2_MDIN0
3	LAN2_MDIP1
4	LAN2_MDIP2
5	LAN2_MDIN2
6	LAN2_MDIN1
7	LAN2_MDIP3
8	LAN2_MDIN3

### 3.6.4 COM Connector

Connector Location: COM2

Description: COM2 Connector

Pin Assignment:

PIN	ASSIGNMENT		
	RS-232 <i>(Default Setting)</i>	RS-422	RS-485
1	DCD#	TX-	RS-485-
2	RX	TX+	RS-485+
3	TX	RX+	NC
4	DTR#	RX-	NC
5	DSR#	NC	NC
6	RTS#	NC	NC
7	CTS#	NC	NC
8	RI#	NC	NC

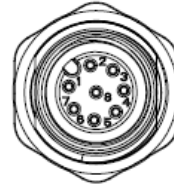

**COM**

### 3.6.5 DC Power Input Connector

Connector Location: DC In

Description: DC Power Input Connector

PIN	ASSIGNMENT
1	PWR_VCC12
2	PWR_GND
3	GND
4	Power BTN

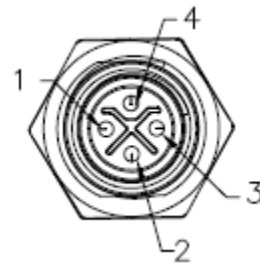

**DC In**

# 4 Software Utilities

---

This chapter provides the detailed information that guides users to install driver utilities for the system. The following topics are included:

- Installing Intel<sup>®</sup> Chipset Software Installation Utility
- Installing Graphics Driver Utility
- Installing Sound Driver Utility
- Installing Intel<sup>®</sup> Management Engine Components Driver Installer
- Installing LAN Driver Utility
- Installing Intel<sup>®</sup> Serial I/O Driver Utility

## 4.1 Introduction

Enclosed with the SG-S156 / SG-S176 / SG-S216 Series package is our driver utilities contained in a DVD-ROM disk. Refer to the following table for driver locations:

Filename (Assume that DVD- ROM drive is D :)	Purpose
D:\Driver\Platform\1_Main Chip\Win10 2016(64Bit)	Intel(R) Chipset Device Software Installation Utility
D:\Driver\Platform\2_Graphics\Win10 2016(64Bit)	Intel Graphics Driver installation
D:\Driver\Platform\3_Sound Codec\Win10 2016(64Bit)	Realtek High Definition Audio driver installation
D:\Driver\Platform\4_ME\Win10 2016(64Bit)	Intel(R) Management Engine Firmware
D:\Driver\Platform\5_LAN Chip\Win10 2016(64Bit)	Intel(R) Network Connections Software
D:\Driver\Platform\6_Serial IO\Win10 2016(64Bit)	Intel(R) Serial IO Driver

**Note:** Install the driver utilities immediately after the OS installation is completed.



## 4.2 Installing Intel® Chipset Software Installation Utility

### Introduction

The Intel® Chipset Software Installation Utility installs the Windows \*.INF files to the target system. These files outline to the operating system how to configure the Intel chipset components in order to ensure that the following functions work properly:

- Core PCI and ISAPNP Services
- PCIe Support
- SATA Storage Support
- USB Support
- Identification of Intel® Chipset Components in the Device Manager

### Intel® Chipset Software Installation Utility

The utility pack is to be installed only for Windows 10 64bit, and it should be installed immediately after the OS installation is finished. Please follow the steps below:

- 1** Connect the USB DVD-ROM device to SG-S156 / SG-S176 / SG-S216 and insert the driver disk.
- 2** Enter the **Main Chip** folder where the Chipset driver is located.
- 3** Click **Setup.exe** file for driver installation.
- 4** Follow the on-screen instructions to install the driver.
- 5** Once the installation is completed, shut down the system and restart SG-S156 / SG-S176 / SG-S216 for the changes to take effect.

### **4.3 Installing Graphics Driver Utility**

The Graphics interface embedded in SG-S156 / SG-S176 / SG-S216 can support dual displays via DP and HDMI interfaces and make the system work simultaneously.

To install the Graphics driver utility, follow the steps below:

- 1** Connect the USB DVD-ROM device to SG-S156 / SG-S176 / SG-S216 and insert the driver disk.
- 2** Enter the **Graphics** folder where the driver is located.
- 3** Click the **Setup.exe** file for driver installation.
- 4** Follow the on-screen instructions to complete the installation.
- 5** Once the installation is completed, shut down the system and restart SG-S156 / SG-S176 / SG-S216 for the changes to take effect.

## **4.4 Installing Sound Driver Utility**

To install the Sound Driver, follow the steps below:

- 1** Connect the USB DVD-ROM device to SG-S156 / SG-S176 / SG-S216 and insert the driver disk.
- 2** Open the **Sound Codec** folder where the driver is located.
- 3** Click the **Setup.exe** file for driver installation.
- 4** Follow the on-screen instructions to complete the installation.
- 5** Once the installation is completed, shut down the system and restart SG-S156 / SG-S176 / SG-S216 for the changes to take effect.

## 4.5 Intel® Management Engine Components Driver Installer Installation

### Installation Instructions for Intel® Management Engine Components Driver Installer

- 1 Connect the USB DVD-ROM device to SG-S156 / SG-S176 / SG-S216 and insert the driver disk.
- 2 Enter the **ME** folder where the driver is located.
- 3 Select Windows 10 (64-bit) for your OS platform.
- 4 Click **Setup.exe** file for ME driver installation.
- 5 Follow the on-screen instructions to complete the installation.
- 6 Once the installation is completed, shut down the system and restart SG-S156 / SG-S176 / SG-S216 for the changes to take effect.

## 4.6 Installing LAN Driver Utility

Enhanced with LAN function, SG-S156 / SG-S176 / SG-S216 supports various network adapters. To install the LAN Driver, follow the steps below:

- 1** Connect the USB DVD-ROM device to SG-S156 / SG-S176 / SG-S216 and insert the driver disk.
- 2** Enter the **LAN Chip** folder where the driver is located.
- 3** Click **Autorun.exe** file for driver installation.
- 4** Follow the on-screen instructions to complete the installation.
- 5** Once the installation is completed, shut down the system and restart SG-S156 / SG-S176 / SG-S216 for the changes to take effect.

**For more details on the installation procedure, refer to the Readme.txt file that you can find on LAN Driver Utility.**

## **4.7 Installing Intel® Serial I/O Driver Utility**

To install the Serial I/O Driver, follow the steps below:

- 1** Connect the USB DVD-ROM device to SG-S156 / SG-S176 / SG-S216 and insert the driver disk.
- 2** Open the **Serial IO** folder where the driver is located.
- 3** Select Windows 10 (64-bit) for your OS platform.
- 4** Click the **Setup.exe** file for driver installation.
- 5** Follow the on-screen instructions to complete the installation.
- 6** Once the installation is completed, shut down the system and restart SG-S156 / SG-S176 / SG-S216 for the changes to take effect.

# 5 BIOS SETUP

---

This chapter guides users how to configure the basic system configurations via the BIOS Setup Utilities. The information of the system configuration is saved in BIOS NVRAM so that the Setup information is retained when the system is powered off. The BIOS Setup Utilities consist of the following menu items:

- Main Menu
- Advanced Menu
- Chipset Menu
- Boot Menu
- Security Menu
- Save & Exit Menu

## 5.1 Introduction

The SG-S156 / SG-S176 / SG-S216 System uses an AMI (American Megatrends Incorporated) Aptio BIOS that is stored in the Serial Peripheral Interface Flash Memory (SPI Flash) and can be updated. The SPI Flash contains the built-in BIOS setup program, Power-On Self-Test (POST), PCI auto-configuration utility, LAN EEPROM information, and Plug and Play support.

Aptio is AMI's BIOS firmware based on the UEFI (Unified Extensible Firmware Interface) specifications and the Intel Platform Innovation Framework for EFI. The UEFI specification defines an interface between the operating system and platform firmware. The interface consists of data tables that contain platform-related information, boot service calls, and runtime service calls that are available to the operating system and its loader. These elements have combined to provide a standard environment for booting the operating system and running pre-boot applications.

The diagram below shows the Extensible Firmware Interface's location in the software stack.

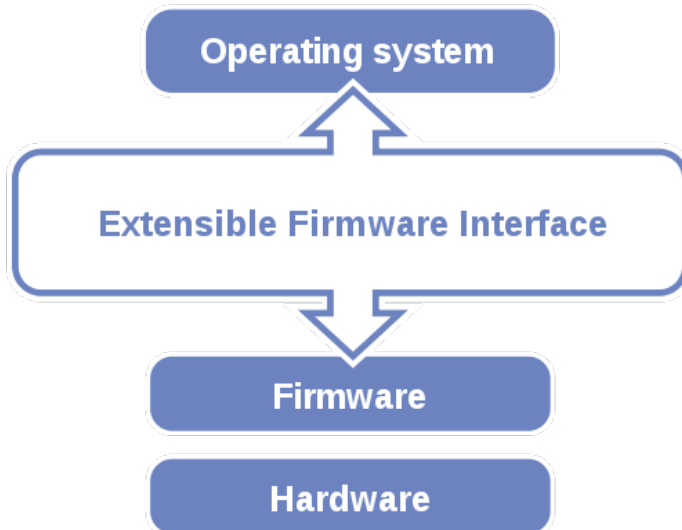

Figure 5-1. Extensible Firmware Interface Diagram



EFI BIOS provides an user interface that allows you to modify hardware configuration, e.g. change the system date and time, enable/disable a system component, determine bootable device priority, set up personal password, etc., which is convenient for engineers to perform modifications and customize the computer system and allows technicians to troubleshoot the occurred errors when the hardware is faulty.

The BIOS setup menu allows users to view and modify the BIOS settings for the computer. After the system is powered on, users can access the BIOS setup menu by pressing <Del> or <Esc> immediately while the POST message is running before the operating system is loading.

All the menu settings are described in details in this chapter.

## 5.2 Accessing Setup Utility

After the system is powered on, BIOS will enter the Power-On Self-Test (POST) routines and the POST message will be displayed:



Figure 5-2. POST Screen with AMI Logo

Press **<Del>** or **<Esc>** to access the Setup Utility program and the **Main** menu of the Aptio Setup Utility will appear on the screen as below:

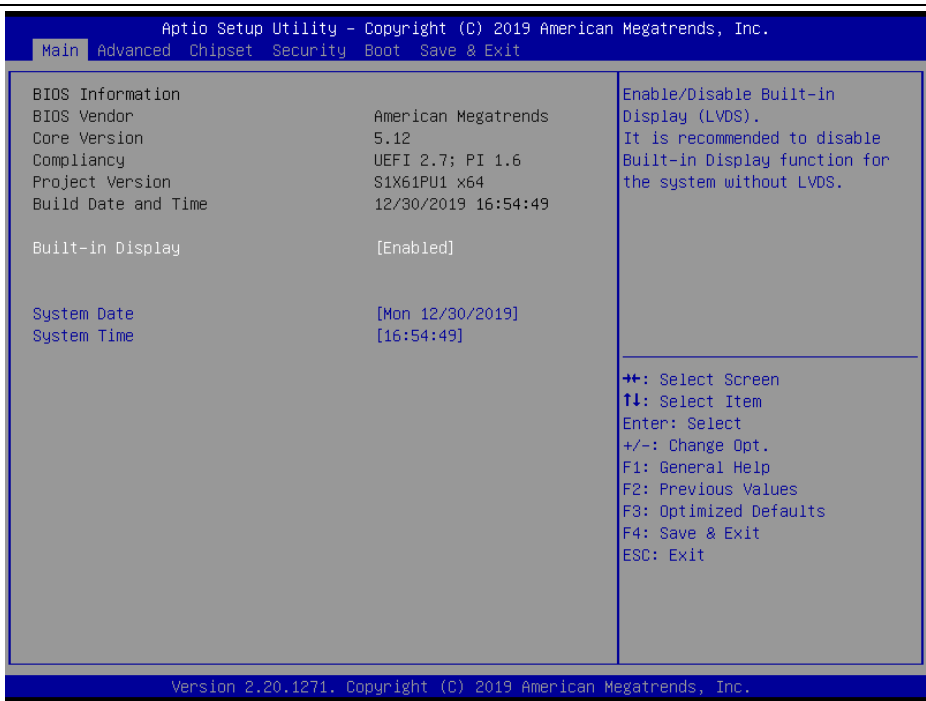

### BIOS Setup Menu Initialization Screen

You may move the cursor by <↑> and <↓> keys to highlight the individual menu items. As you highlight each item, a brief description of the highlighted selection will appear on the right side of the screen.

The language of the BIOS setup menu interface and help messages are shown in US English. You may use <↑> or <↓> key to select among the items and press <Enter> to confirm and enter the sub-menu. The following table provides the list of the navigation keys that you can use while operating the BIOS setup menu.

<b>BIOS Setup Navigation Key</b>	<b>Description</b>
<←> and <→>	Select a different menu screen (move the cursor from the selected menu to the left or right).
<↑> and <↓>	Select a different item (move the cursor from the selected item upwards or downwards)
<Enter>	Execute the command or select the sub-menu.
<F2>	Load the previous configuration values.
<F3>	Load the default configuration values.
<F4>	Save the current values and exit the BIOS setup menu.
<Esc>	Close the sub-menu. Trigger the confirmation to exit BIOS setup menu.

### 5.3 Main

Menu Path *Main*

The **Main** menu allows you to view the BIOS Information, change the system date and time, and view the user access privilege level. Use tab to switch between date elements. Use <↑> or <↓> arrow keys to highlight the item and enter the value you want in each item. This screen also displays the BIOS version (project) and BIOS Build Date and Time.

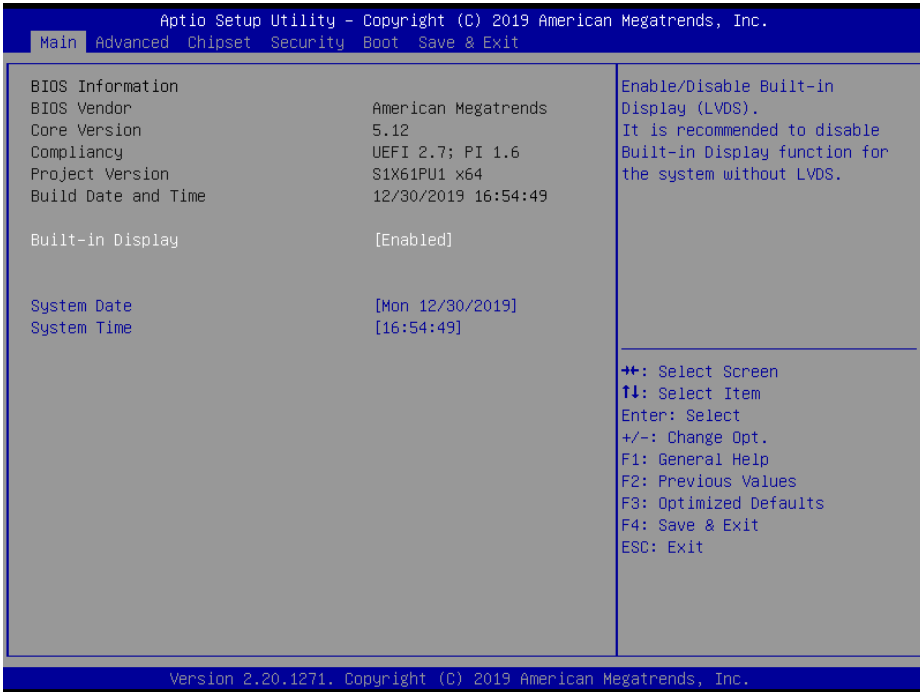

**Main Screen**

BIOS Setting	Options	Description/Purpose
BIOS Vendor	No changeable options	Displays the name of the BIOS vendor.
Core Version	No changeable options	Displays the current BIOS core version.
Compliancy	No changeable options	Displays the current UEFI version.
Project Version	No changeable options	Displays the version of the BIOS currently installed on the platform.
Build Date and Time	No changeable options	Displays the date that the current BIOS version is built.
Built-in Display	- Disabled - Enabled	Enables/Disables Built-in Display (LVDS). It is recommended to disable Built-in Display function for the system without LVDS.

<b>BIOS Setting</b>	<b>Options</b>	<b>Description/Purpose</b>
System Date	Month, day, year	Sets the system date. The format is [Day Month/ Date/ Year]. Users can directly enter values or use <+> or <-> arrow keys to increase/decrease it. The “Day” is automatically changed.
System Time	Hour, minute, second	Sets the system time. The format is [Hour: Minute: Second]. Users can directly enter values or use <+> or <-> arrow keys to increase/decrease it.

## 5.4 Advanced

Menu Path                      *Advanced*

This menu provides advanced the sub-menu items such as CPU Configuration, SATA Configuration, PCH-FW Configuration, Trusted Computing, ACPI Settings, F81866 Super IO Configuration, Hardware Monitor, F81866 Watchdog, S5 RTC Wake Settings , USB Configuration and Network Stack Configuration.

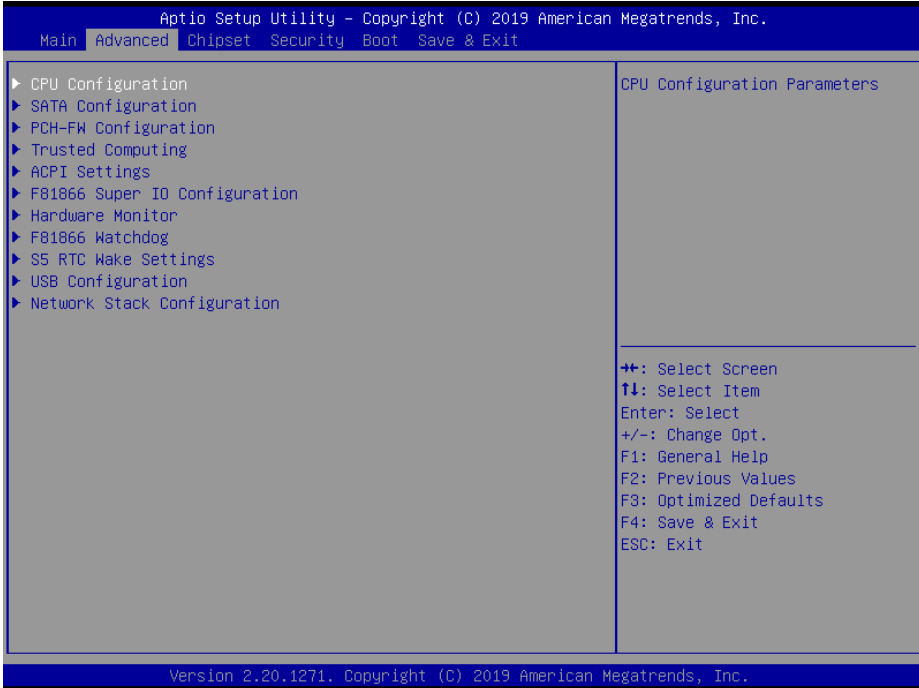

**Advanced Menu Screen**

BIOS Setting	Options	Description/Purpose
CPU Configuration	Sub-Menu	CPU Configuration Parameters.
SATA Configuration	Sub-Menu	SATA Device Options Settings.
PCH-FW Configuration	Sub-Menu	Management Engine Technology Parameters.
Trusted Computing	Sub-Menu	Trusted Computing Settings.
ACPI Settings	Sub-Menu	System ACPI Parameters.
F81866 Super IO Configuration	Sub-Menu	System Super I/O Chip Parameters.
Hardware Monitor	Sub-Menu	Monitor hardware status.
F81866 Watchdog	Sub-Menu	F81866 Watchdog Parameters.
USB Configuration	Sub-Menu	USB Configuration Parameters.

BIOS Setting	Options	Description/Purpose
S5 RTC Wake Settings	Sub-Menu	Enables system to wake from S5 using RTC alarm.
Network Stack Configuration	Sub-Menu	Network Stack Settings

### 5.4.1 Advanced – CPU Configuration

Menu Path *Advanced > CPU Configuration*

The **CPU Configuration** provides advanced CPU settings and some information about CPU.

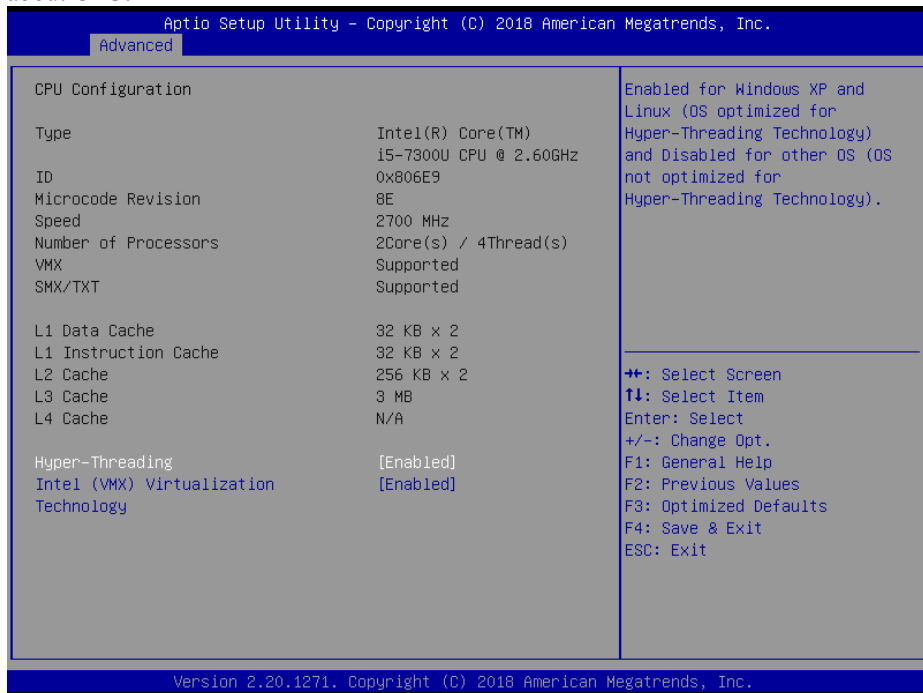

**CPU Configuration Screen**

BIOS Setting	Options	Description/Purpose
Type	No changeable options	Displays the CPU Type.
ID	No changeable options	Displays the CPU ID.
Microcode Revision	No changeable options	Displays the CPU Microcode Revision.
Speed	No changeable options	Displays the CPU Speed.
Number of Processors	No changeable options	Displays the number of CPU processors.
VMX	No changeable options	CPU VMX hardware support for virtual machines.



BIOS Setting	Options	Description/Purpose
SMX (Secure Mode Extensions) /TXT	No changeable options	Secure Mode extensions support.
L1 Data Cache	No changeable options	Displays L1 Data Cache Size.
L1 Instruction Cache	No changeable options	Displays L1 Instruction Cache Size.
L2 Cache	No changeable options	Displays L2 Cache Size.
L3 Cache	No changeable options	Displays L3 Cache Size.
L4 Cache	No changeable options	Displays L4 Cache Size.
Hyper-Threading	- Disabled - Enabled	When Disabled, only one thread per enabled core is enabled.
Intel (VMX) Virtualization Technology	- Disabled - Enabled	When enabled, VMM can utilize the additional hardware capabilities provided by Vanderpool Technology

### 5.4.2 Advanced – SATA Configuration

Menu Path *Advanced > SATA Configuration*

The **SATA Configuration** allows users to enable / disable the SATA controller as well as the operational mode after the SATA controller is enabled. The following screen indicates the functions available when the SATA controller is enabled and the AHCI mode is selected.



**SATA Configuration Screen**

BIOS Setting	Options	Description/Purpose
SATA Controller(s)	- Disabled - Enabled	Enables or Disables SATA Device.
SATA Mode Selection	- AHCI	Determines how SATA controller(s) operate.
Serial ATA Port 0 – 1	No changeable options	Displays the SATA device's name.
Software Preserve	No changeable options	Indicates whether the connected SATA device supports Software Setting Preservation (SSP).
Port 0 - 1	- Disabled - Enabled	Enables or Disables SATA Port Device.
Hot Plug	- Disabled - Enabled	Enables or Disables Hot Plug function to designate a SATA port device as hot-pluggable.

### 5.4.3 Advanced – PCH-FW Configuration

Menu Path *Advanced > PCH-FW Configuration*

The **PCH-FW** allows users to view the information about ME (Management Engine) firmware information, such ME firmware version, firmware mode and firmware SKU.

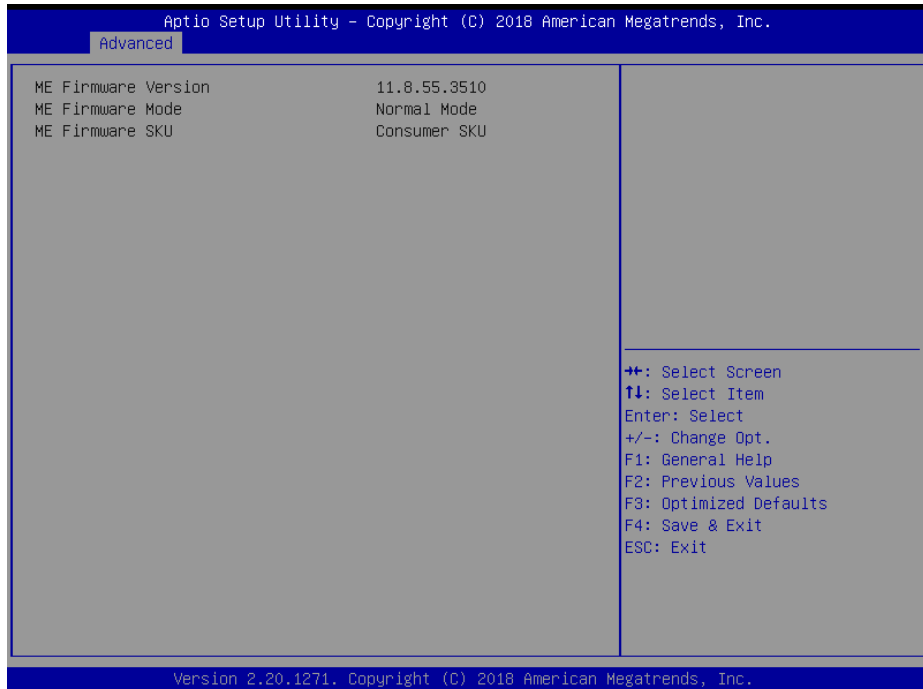

**PCH-FW Configuration Screen**

BIOS Setting	Options	Description/Purpose
ME Firmware Version	No changeable options	Displays the ME Firmware Version.
ME Firmware Mode	No changeable options	Displays the ME Firmware Mode.
ME Firmware SKU	No changeable options	Displays the ME Firmware SKU.

### 5.4.4 Advanced – Trusted Computing

Menu Path *Advanced > Trusted Computing*

The Trusted Computing allows users to enable/disable BIOS support for security device. The operating system will not show Security Device. The TCG EFI protocol and INT1A interface will not be available.

\*Trusted Computing Screen function is for "CPU i5-7300U" SKU only.



#### Trusted Computing Screen

BIOS Setting	Options	Description/Purpose
Firmware Version	No changeable options	Displays the Firmware Version.
Vendor	No changeable options	Displays the Vendor information.
Security Device Support	- Disabled - Enabled	Enables or Disables BIOS support for security device. O.S. will not show Security Device. TCG EFI protocol and INT1A interface will not be available.
Active PCR banks	No changeable options	Displays the Active PCR banks.
Available PCR banks	No changeable options	Displays the Available PCR banks.
SHA-1 PCR Bank	- Disabled - Enabled	Enables or Disables SHA-1 PCR Bank.
SHA256 PCR Bank	- Disabled - Enabled	Enables or Disables SHA256 PCR Bank.
Pending operation	- None - TPM Clear	Schedules an operation for the Security Device. Note: Your Computer will reboot during restart in order to change State of Security Device.
Platform Hierarchy	- Disabled - Enabled	Enables or Disables the Platform Hierarchy.
Storage Hierarchy	- Disabled - Enabled	Enables or Disables the Storage Hierarchy.
Endorsement Hierarchy	- Disabled - Enabled	Enables or Disables the Endorsement Hierarchy.
TPM2.0 UEFI Spec Version	- TCG_1_2 - TCG_2	Selects the TCG2 Spec Version Support, TCG_1_2: the Compatible mode for Win8/Win10, TCG_2: Support new TCG2 protocol and event format for Win10 or later.
Physical Presence Spec Version	- 1.2 - 1.3	Selects to tell O.S to support PPI Spec. version 1.2 or 1.3. Note some HCK tests might not support Spec. version 1.3.
TPM 20 InterfaceType	No changeable options	Displays the TPM 20 Interface Type.
Device Select	- TPM 1.2 - TPM 2.0 - Auto	<ul style="list-style-type: none"> <li>• <b>TPM 1.2:</b> Restricts support to TPM 1.2 devices.</li> <li>• <b>TPM 2.0:</b> Restricts support to TPM 2.0 devices</li> <li>• <b>Auto:</b> Supports both TPM 1.2 and TPM 2.0 with the default setting set to TPM 2.0 devices if not found. TPM 1.2 devices will be enumerated.</li> </ul>

### 5.4.5 Advanced – ACPI Settings

Menu Path *Advanced > ACPI Settings*

The **ACPI Settings** allows users to configure relevant ACPI (Advanced Configuration and Power Management Interface) settings, such as enable/disable Hibernation, ACPI Sleep State, Lock legacy resources and S3 Video Repost.

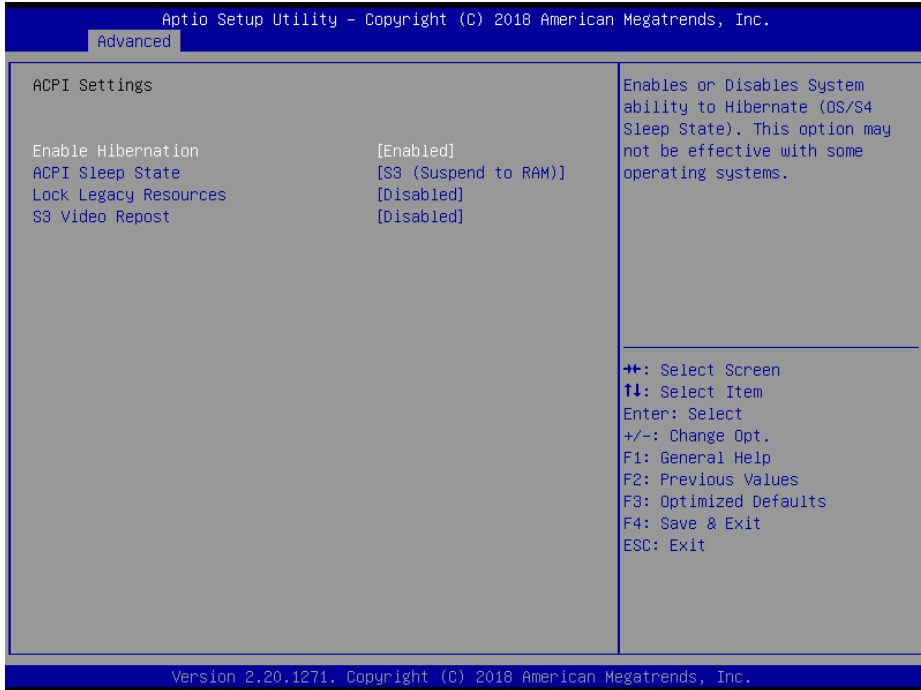

**ACPI Settings Screen**

BIOS Setting	Options	Description/Purpose
Enable Hibernation	- Disabled - Enabled	Enables or Disables System ability to Hibernate (OS/S4 Sleep State). This option may be not effective with some OS.
ACPI Sleep State	- Suspend Disabled - S3 (Suspend to RAM)	Selects the highest ACPI sleep state the system will enter when the SUSPEND button is pressed.
Lock Legacy Resources	- Disabled - Enabled	Enables or Disables Lock of Legacy Resources.
S3 Video Repost	- Disabled - Enabled	Enables or Disables S3 Video Repost.

## 5.4.6 Advanced – F81866 Super IO Configuration

Menu Path *Advanced > F81866 Super IO Configuration*

The **F81866 Super IO Configuration** allows users to configure the serial ports 1-2.

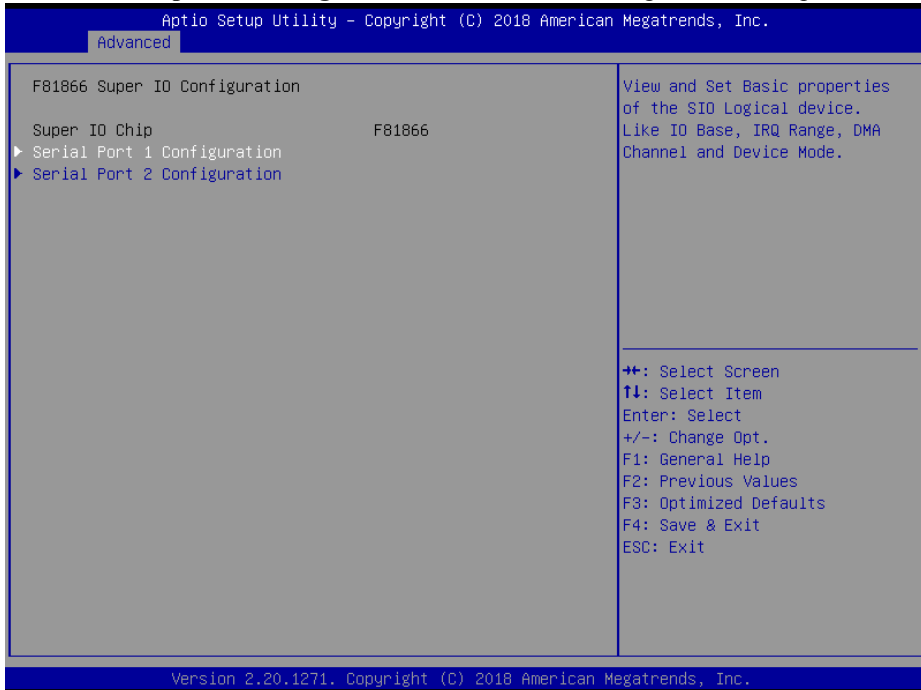

**F81866 Super IO Configuration Screen**

BIOS Setting	Options	Description/Purpose
Serial Port 1 Configuration	Sub-Menu	Configures Parameters of Serial Port 1 (COMA).
Serial Port 2 Configuration	Sub-Menu	Configures Parameters of Serial Port 2 (COMB).

**F81866 Super IO Configuration – Serial Port 1 Configuration**

Menu Path                    *Advanced > F81866 Super IO Configuration > Serial Port 1 Configuration*



**Serial Port 1 Configuration Screen**

BIOS Setting	Options	Description/Purpose
Use This Device	- Disabled - Enabled	Enables or Disables Serial Port 1.
Device Settings	No changeable options	Displays the current settings of Serial Port 1.
Change Settings	- Auto - IO=3F8h; IRQ=4; - IO=3F8h; IRQ=3,4,5,7,10,11,12; - IO=2F8h; IRQ=3,4,5,7,10,11,12; - IO=3E8h; IRQ=3,4,5,7,10,11,12; - IO=2E8h; IRQ=3,4,5,7,10,11,12;	Selects IRQ and I/O resource settings for Serial Port 1.
Mode	- RS-232 - RS-422 - RS-485	Selects COM1 mode.

**F81866 Super IO Configuration – Serial Port 2 Configuration**

Menu Path                    *Advanced > F81866 Super IO Configuration > Serial Port 2 Configuration*



**Serial Port 2 Configuration Screen**

BIOS Setting	Options	Description/Purpose
Use This Device	- Disabled - Enabled	Enables or Disables Serial Port 2.
Device Settings	No changeable options	Displays the current settings of Serial Port 2.
Change Settings	- Auto - IO=2F8h; IRQ=3; - IO=3F8h; IRQ=3,4,5,7,10,11,12; - IO=2F8h; IRQ=3,4,5,7,10,11,12; - IO=3E8h; IRQ=3,4,5,7,10,11,12; - IO=2E8h; IRQ=3,4,5,7,10,11,12;	Selects IRQ and I/O resource settings for Serial Port 2.
Mode	- RS-232 - RS-422 - RS-485	Selects COM2 mode.



## 5.4.7 Advanced – Hardware Monitor

Menu Path *Advanced > Hardware Monitor*

The **Hardware Monitor** allows users to configure the smart fan mode and monitor the health and status of the system such as CPU temperature, system temperature, CPU fan speed and voltage levels in supply.

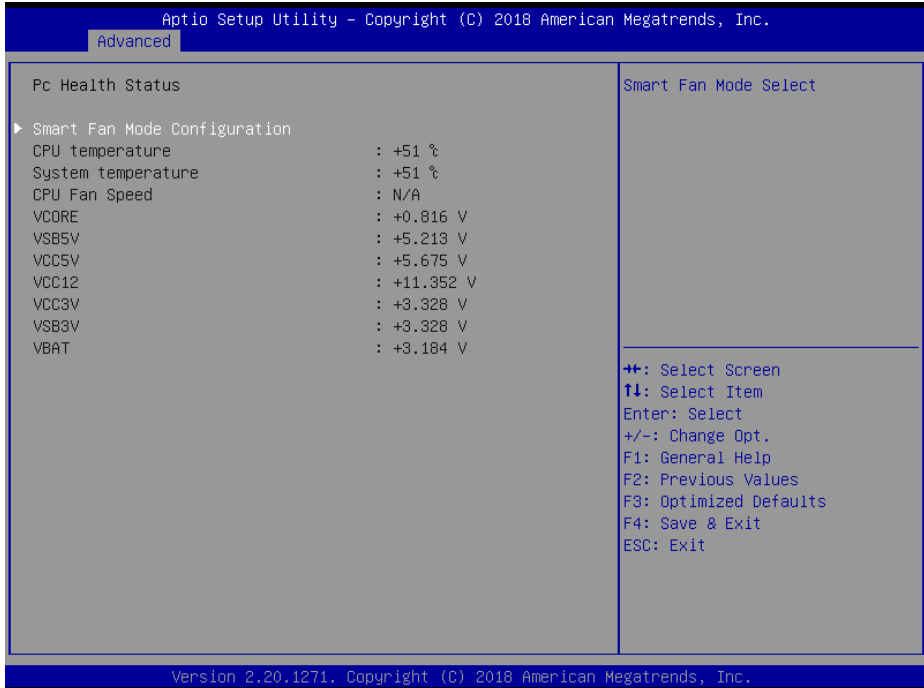

**Hardware Monitor Screen**

BIOS Setting	Options	Description/Purpose
Smart Fan Mode Configuration	Sub-Menu	Smart Fan Mode Selection
CPU temperature	No changeable options	Displays the processor's temperature.
System temperature	No changeable options	Displays the system temperature.
CPU Fan Speed	No changeable options	Displays CPU Fan speed.
V CORE	No changeable options	Detects and displays the voltage level of the V CORE in supply.
VSB5V	No changeable options	Detects and displays the voltage level of the VSB5V in supply.

BIOS Setting	Options	Description/Purpose
VCC5V	No changeable options	Detects and displays the voltage level of VCC5V in supply.
VCC12	No changeable options	Detects and displays the voltage level of VCC12 in supply.
VCC3V	No changeable options	Detects and displays the voltage level of VCC3V in supply.
VSB3V	No changeable options	Detects and displays the voltage level of VSB3V in supply.
VBAT	No changeable options	Detects and displays the battery voltage.

### Smart Fan Mode Configuration

Menu Path *Advanced > Hardware Monitor > Smart Fan Mode Configuration*

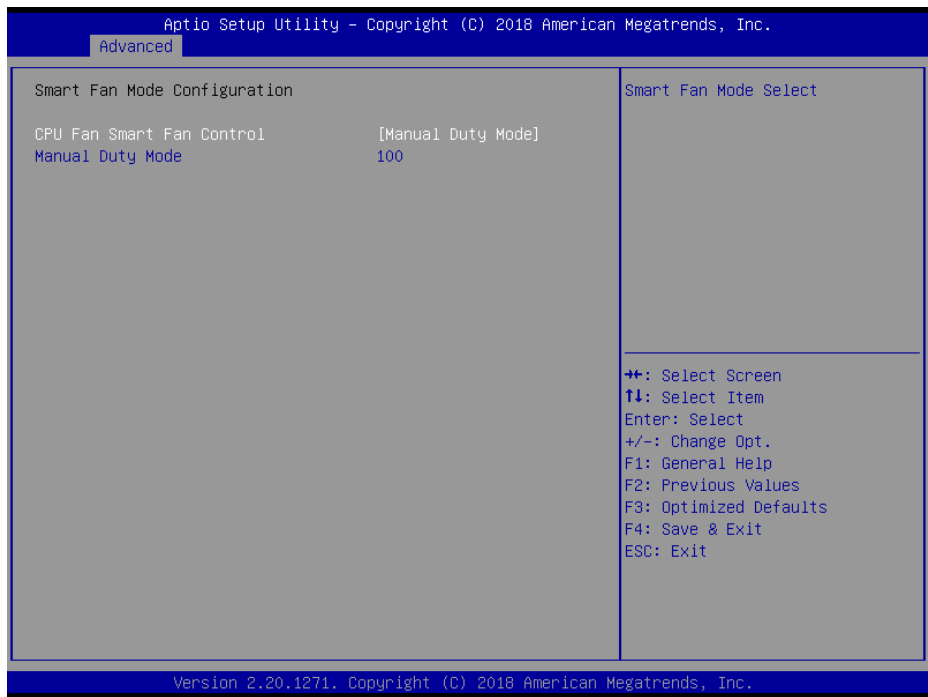

Smart Fan Mode Configuration Screen

BIOS Setting	Options	Description/Purpose
CPU Fan Smart Fan Control	- Manual Duty Mode - Auto Duty-Cycle Mode	Smart Fan Mode selection for CPU Fan.

BIOS Setting	Options	Description/Purpose
Manual Duty Mode	Numeric (from 1 to 100)	Manual mode fan control. Users can write expected duty cycle (PWM fan type) from 1 to 100.

### 5.4.8 Advanced – F81866 Watchdog

Menu Path *Advanced > F81866 Watchdog*

If the system hangs or fails to respond, enable the F81866 watchdog function to trigger a system reset via the 255-level watchdog timer.

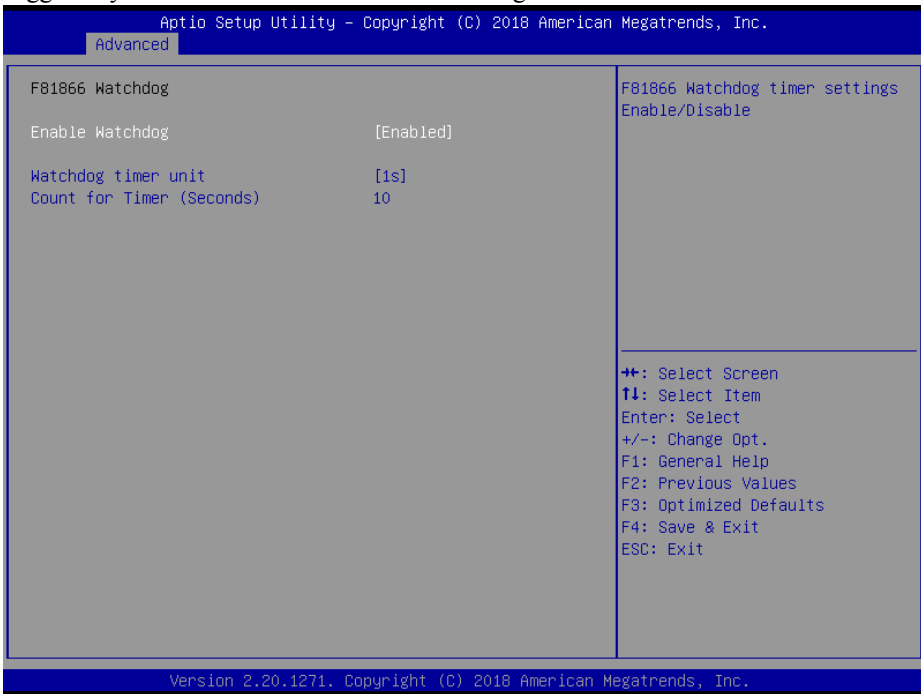

**F81866 Watchdog Screen**

BIOS Setting	Options	Description/Purpose
Enable Watchdog	- Enabled - Disabled	Enables/Disables F81866 Watchdog timer settings.
Watchdog timer unit	- 1s - 60s	Watchdog timer unit.
Count for Timer (Seconds)	Numeric (from 1 to 255)	The number of count for Timer.

## 5.4.9 Advanced – S5 RTC Wake Settings

Menu Path *Advanced > S5 RTC Wake Settings (Disabled)*

The **S5 RTC Wake Settings** enables/disables the system to wake up at a preset time of a day from S5 State using RTC alarm.

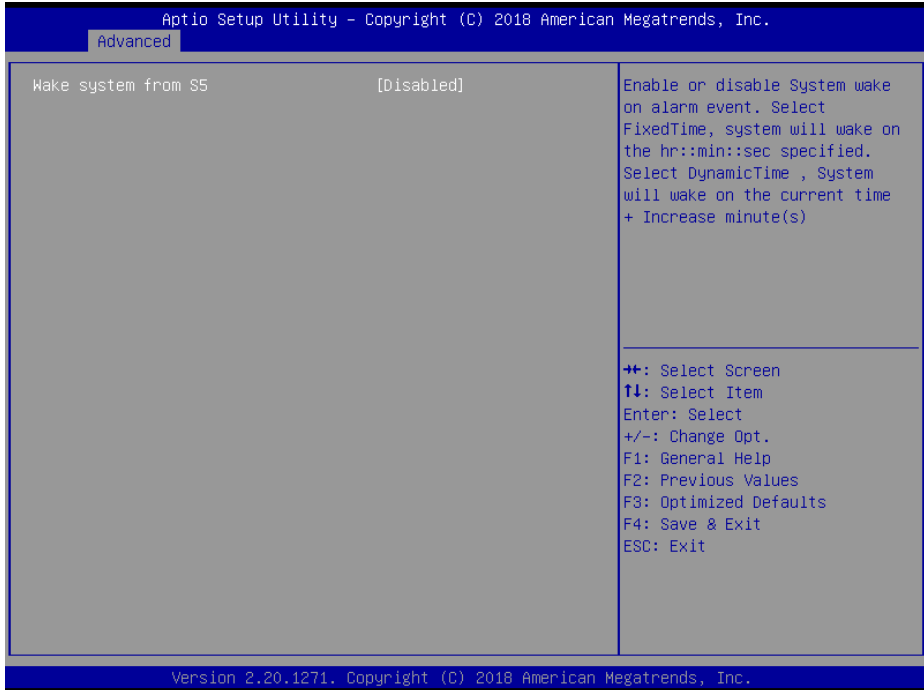

**S5 RTC Wake Settings Screen (Disabled)**

BIOS Setting	Options	Description/Purpose
Wake system from S5	<ul style="list-style-type: none"> <li>- Disabled</li> <li>- Fixed Time</li> <li>- Dynamic Time</li> </ul>	<p>Allows enabling scheduled S5 to S0 (option <b>enabled</b>).</p> <ul style="list-style-type: none"> <li>• <b>Fixed Time:</b> System will wake on the hr::min::sec specified.</li> <li>• <b>Dynamic Time:</b> System will wake on the current time + Increased minute(s).</li> </ul>

Menu Path *Advanced > S5 RTC Wake Settings (Fixed Time)*

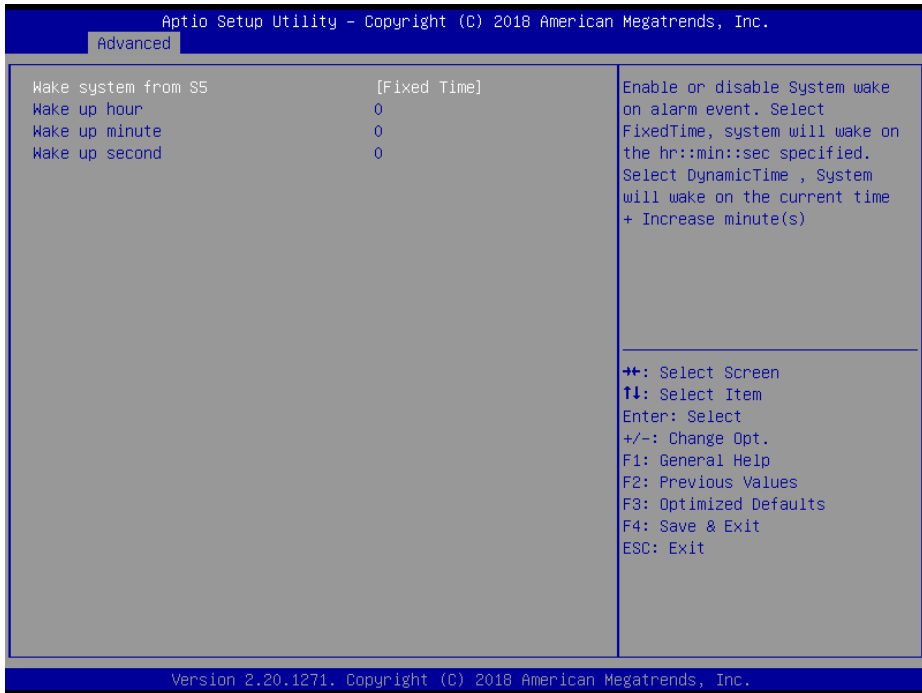

**S5 RTC Wake Settings Screen (Fixed Time)**

BIOS Setting	Options	Description/Purpose
Wake system from S5	- Disabled - <b>Fixed Time (selected)</b> - Dynamic Time	<ul style="list-style-type: none"> <li>• <b>Fixed Time:</b> System will wake on the hr::min::sec specified.</li> </ul>
Wake up hour	Multiple options ranging from 0 to 23	Specifies an hour for a scheduled power-on event.
Wake up minute	Multiple options ranging from 0 to 59	Specifies a minute for a schedule power-on event.
Wake up second	Multiple options ranging from 0 to 59	Specifies a second for a schedule power-on event.

Menu Path *Advanced > S5 RTC Wake Settings (Dynamic Time)*

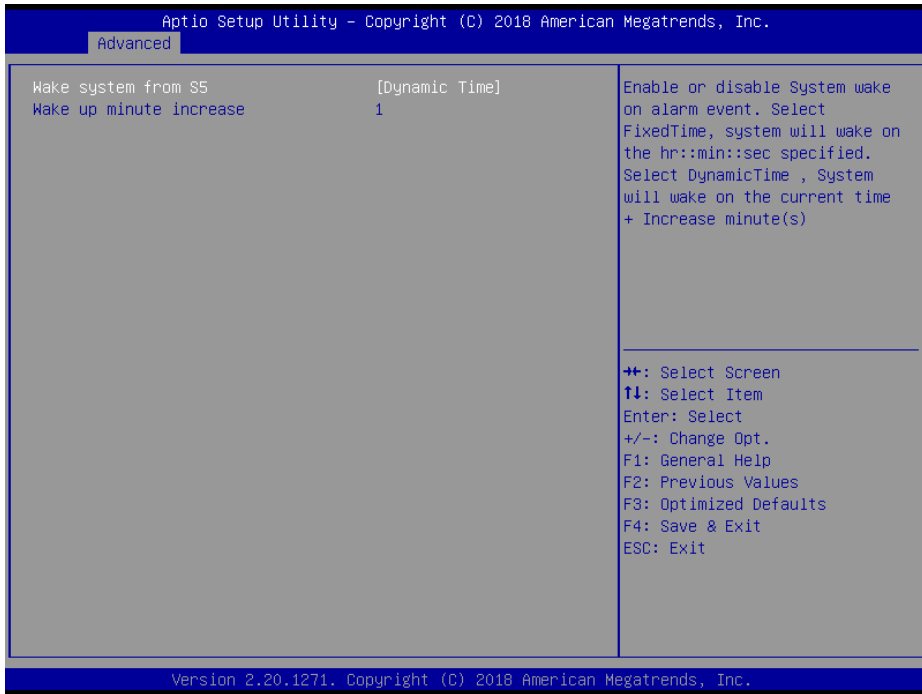

**S5 RTC Wake Settings Screen (Dynamic Time)**

BIOS Setting	Options	Description/Purpose
Wake system from S5	- Disabled - Fixed Time - <b>Dynamic Time (selected)</b>	<ul style="list-style-type: none"> <li>• <b>Dynamic Time:</b> System will wake on the current time + Increased minute(s).</li> </ul>
Wake up minute increase	Multiple options ranging from 1 to 5	Sets a period of time (in minutes) after which the board wakes up from S5 state.

### 5.4.10 Advanced – USB Configuration

Menu Path *Advanced > USB Configuration*

The **USB Configuration** allows users to configure advanced USB settings such as legacy USB support.

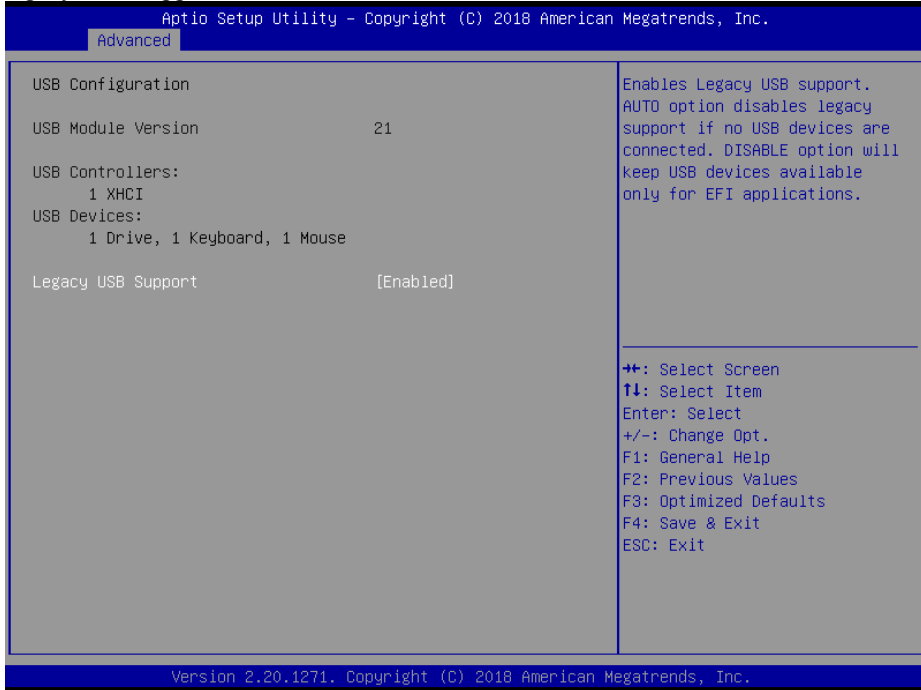

**USB Configuration Screen**

BIOS Setting	Options	Description/Purpose
Legacy USB Support	- Disabled - Enabled	Enables/Disables Legacy USB Support.

### 5.4.11 Advanced – Network Stack Configuration

Menu Path *Advanced > Network Stack Configuration*

The **Network Stack Configuration** allows users to enable/disable UEFI Network Stack, IPv4/IPv6 PXE (Pre-Boot Execution) support and configure PXE boot wait time and detects the media presence.

PXE allows a workstation to boot from a server on a network prior to booting the operating system on the local hard drive. A PXE-enabled workstation connects its NIC to the LAN via a jumper, which keeps the workstation connected to the network even when the power is turned off.

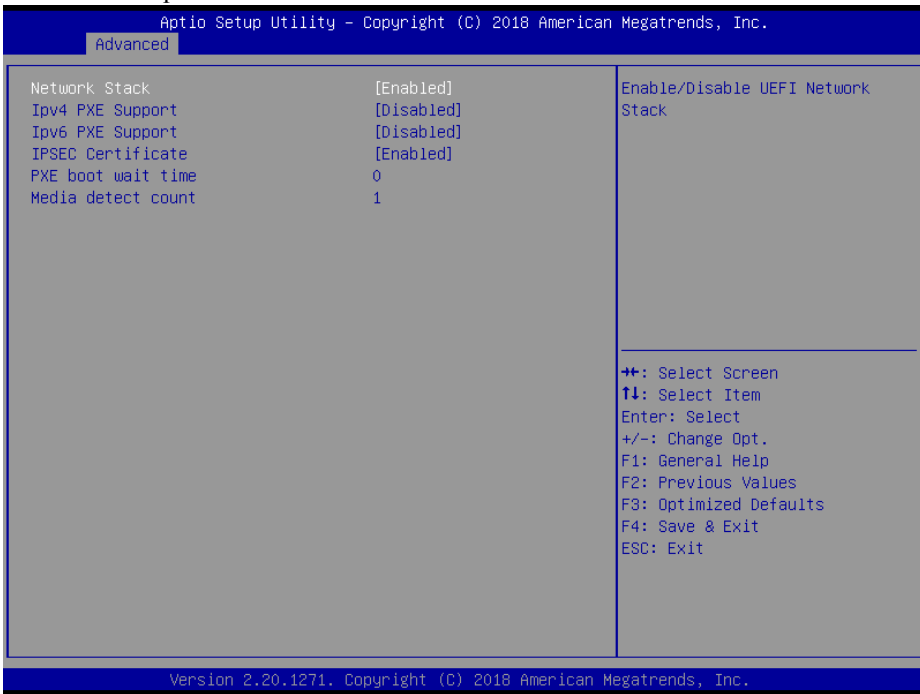

**Network Stack Configuration Screen**

BIOS Setting	Options	Description/Purpose
Network Stack	- Disabled - Enabled	Enables or Disables UEFI Network Stack.
Ipv4 PXE Support	- Disabled - Enabled	Enables Ipv4 PXE Boot Support. If disabled, Ipv4 PXE boot option will not be created.
Ipv6 PXE Support	- Disabled - Enabled	Enables Ipv6 PXE Boot Support. If disabled, Ipv6 PXE boot option will not be created.



<b>BIOS Setting</b>	<b>Options</b>	<b>Description/Purpose</b>
IPSEC Certificate	- Disabled - Enabled	Support to enable/disable IPSEC certificate for Ikev.
PXE boot wait time	Numeric (from 0 to 5)	Number of seconds to wait for PXE boot to abort after the Esc key is pressed.
Media detect count	Numeric (from 1 to 50)	Number of times that the media presence will be checked.

## 5.5 Chipset

Menu Path *Chipset*

This menu allows users to configure advanced Chipset settings such as System Agent (SA) and PCH-IO configuration parameters.

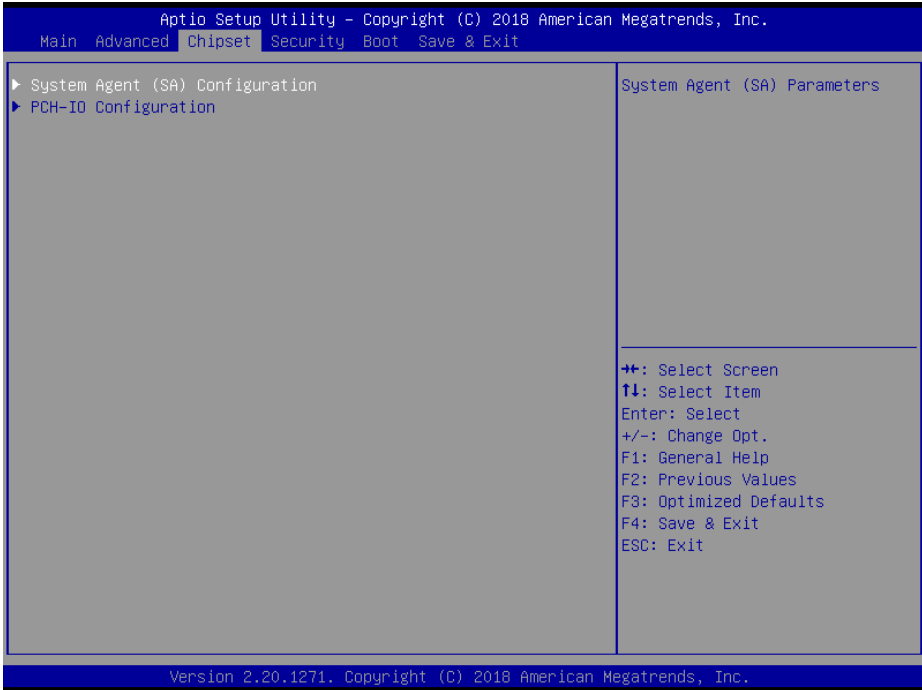

**Chipset Screen**

BIOS Setting	Options	Description/Purpose
System Agent (SA) Configuration	Sub-Menu	System Agent (SA) Parameters.
PCH-IO Configuration	Sub-Menu	PCH Parameters.

## 5.5.1 Chipset – System Agent (SA) Configuration

Menu Path *Chipset > System Agent (SA) Configuration*

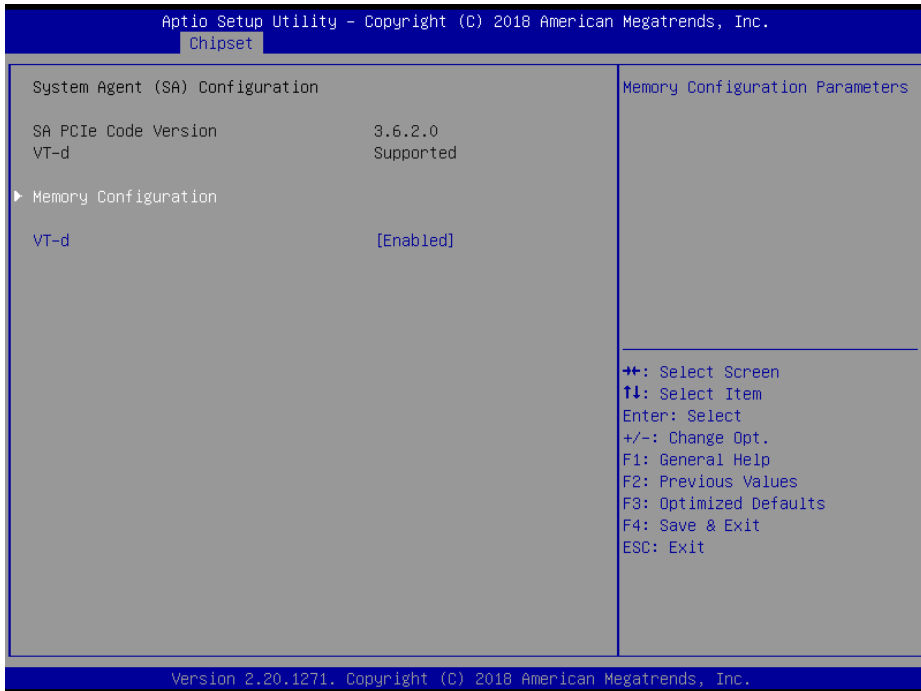

**System Agent (SA) Configuration Screen**

BIOS Setting	Options	Description/Purpose
SA PCIe Code Version	No changeable options	Displays the SA PCIe Code Version.
VT-d	No changeable options	Supports VT-d capability.
Memory Configuration	Sub-Menu	Memory Configuration.
VT-d	- Disabled - Enabled	Enables or Disables VT-d function.

## System Agent (SA) Configuration – Memory Configuration

Menu Path *Chipset > System Agent (SA) Configuration > Memory Configuration*

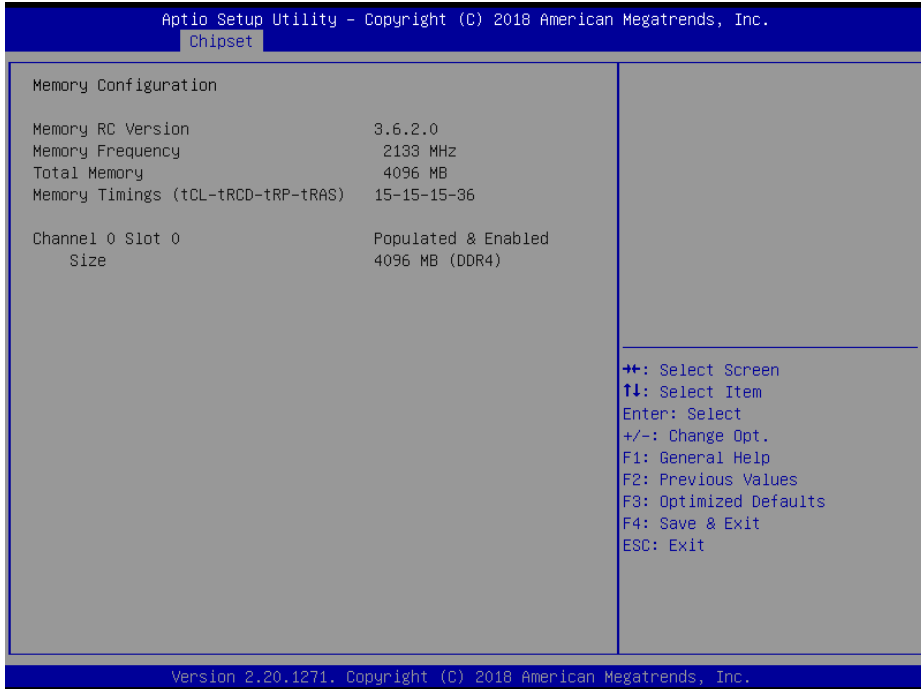

**Memory Configuration Screen**

BIOS Setting	Options	Description/Purpose
Memory RC Version	No changeable options	Displays the Memory RC Version.
Memory Frequency	No changeable options	Displays the Frequency of Memory.
Total Memory	No changeable options	Displays the Total Memory.
Memory Timings (tCL-tRCD-tRP-tRAS)	No changeable options	Displays the Memory Timings.
Channel 0 Slot 0	No changeable options	Displays the Channel 0 Slot 0 Subtitle.
Size	No changeable options	Displays the size of Channel 0 Slot 0.

## 5.5.2 Chipset – PCH IO Configuration

Menu Path *Chipset > PCH-IO Configuration*

The **PCH-IO Configuration** allows users to configure North Bridge chipset, set PCI Express configuration parameters, enable/disable PCH LAN Controller and Wake-On-LAN function and determine the power on/off state that the system will go to following a power failure (G3 state).



**PCH-IO Configuration Screen**

BIOS Setting	Options	Description/Purpose
Name	No changeable options	Displays the Intel PCH Name.
PCH SKU	No changeable options	Displays the Intel PCH SKU.
Stepping	No changeable options	Displays the Intel PCH Stepping.
PCI Express Configuration	Sub-Menu	PCI Express Configuration settings.
PCH LAN Controller	- Disabled - Enabled	Enables or Disables onboard NIC.
Wake on LAN Enable	- Disabled - Enabled	Enables or Disables integrated LAN to wake the system.

BIOS Setting	Options	Description/Purpose
State After G3	- Power On - Power Off	Specifies the Power On/Off state that the system will go to after the power is re-applied following a power failure (G3 state).

### PCH-IO Configuration – PCI Express Configuration

Menu Path *Chipset > PCH-IO Configuration > PCI Express Configuration*

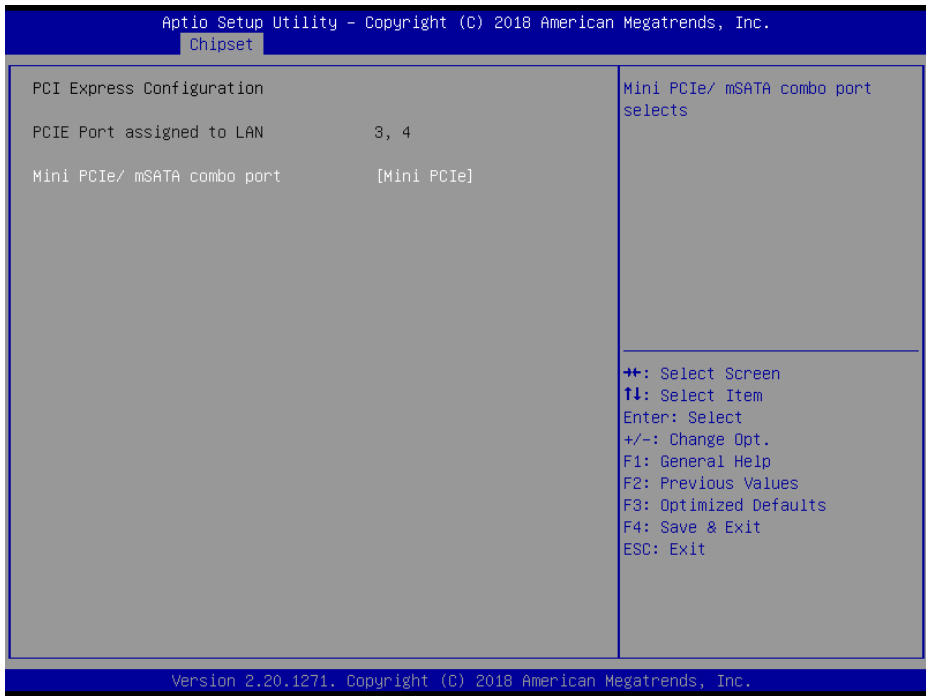

**PCI Express Configuration Screen**

\* Mini PCIe/ mSATA combo port function is supported for "CPU i5-7300U" SKU only.

BIOS Setting	Options	Description/Purpose
PCIe Port assigned to LAN	No changeable options	Displays the LAN assigned PCIe Port.
Mini PCIe/ mSATA combo port	- Mini PCIe - mSATA	Mini PCIe/ mSATA combo port selection.

## 5.6 Security

Menu Path                      *Security*

From the **Security** menu, you are allowed to create, change or clear the administrator password. You will be asked to enter the configured administrator password before you can access the Setup Utility.

By setting an administrator password, you will prevent other users from changing your BIOS settings. You can configure an Administrator password and then configure a user password. An administrator has much more privileges over the settings in the Setup utility than a user. Heed that a user password does not provide access to most of the features in the Setup utility.

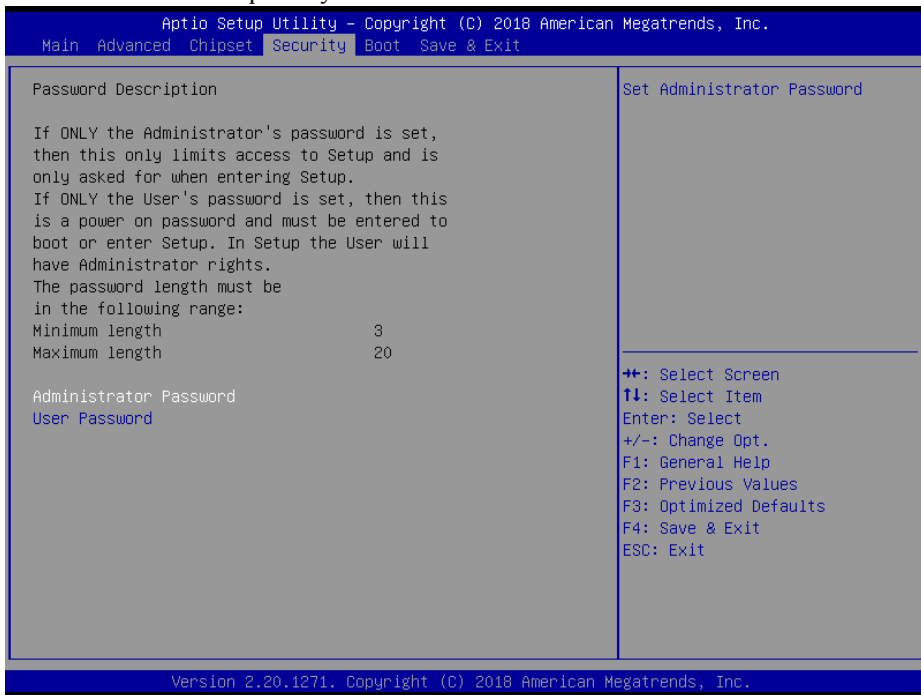

### Security Screen

<b>BIOS Setting</b>	<b>Options</b>	<b>Description/Purpose</b>
Administrator Password	Password can be 3-20 alphanumeric characters.	Specifies the administrator password.
User Password	Password can be 3-20 alphanumeric characters.	Specifies the user password.

**Create an Administrator or User Password**

1. Select the **Administrator Password / User Password** option from the Security menu and press <Enter>, and the password dialog entry box appears.
2. Enter the password you want to create. A password can be 3-20 alphanumeric characters. After you have configured the password, press <Enter> to confirm.
3. Type the new password again and press <Enter>.

**Change an Administrator or User Password**

1. Select the **Administrator Password / User Password** option from the Security menu and press <Enter>, and the password dialog entry box appears.
2. Select the Administrator Password or User Password that you want to change. A password can be 3-20 alphanumeric characters. After you have changed the password, press <Enter> to confirm.
3. Type the changed password again and press <Enter>.

**Remove an Administrator or User Password**

1. Select the **Administrator Password / User Password** option from the Security menu and press <Enter>, and the password dialog entry box appears.
2. Select the configured Administrator Password or User Password that you want to delete. Leave the dialog box blank and press <Enter>.
3. Press <Enter> again when the password confirmation box appears.



## 5.7 Boot

Menu Path *Boot*

This menu provides control items for system boot configuration such as setting setup prompt timeout, enabling/disabling quiet boot and fast boot and changing the boot order from the available bootable device(s).

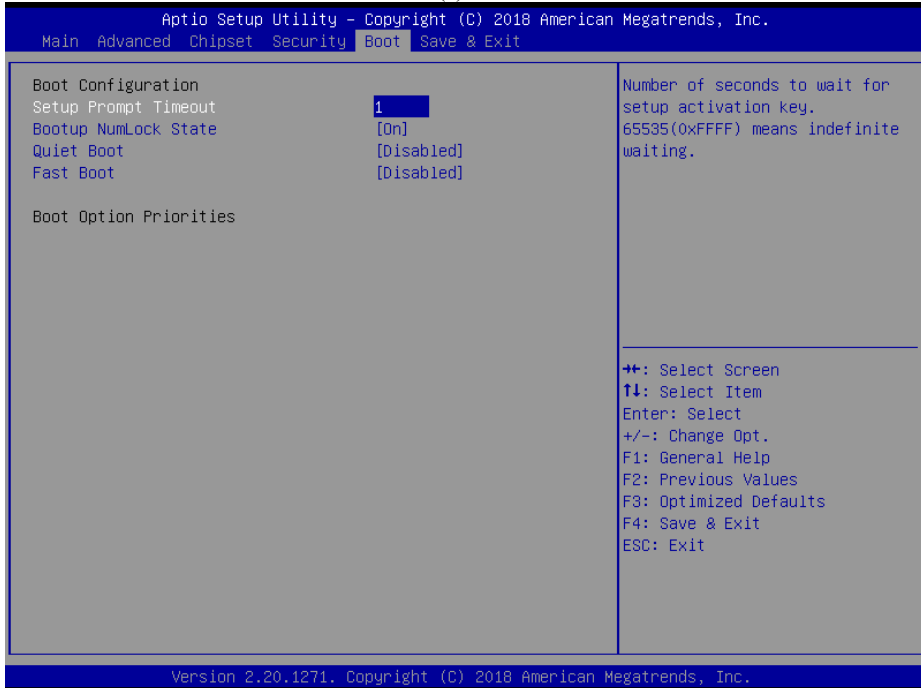

**Boot Screen**

BIOS Setting	Options	Description/Purpose
Setup Prompt Timeout	Numeric (from 1 to 65535)	Number of seconds to wait for setup activation key.
Bootup NumLock State	- On - Off	Specifies the power-on state of the NumLock Key.
Quiet Boot	- Disabled - Enabled	Enables or Disables Quiet Boot options.
Fast Boot	- Disabled - Enabled	Enables or Disables Fast Boot options.
Boot Option #1~#n	- [Drive(s)] - Disabled	Sets the system boot order.

## 5.8 Save & Exit

Menu Path *Save & Exit*

The **Save & Exit** allows users to save or discard changed BIOS settings as well as load factory default settings.

### Save Changed BIOS Settings

To save and validate the changed BIOS settings, select **Save Changes** from the **Save & Exit** menu, or you can select **Save Changes and Exit** (or press **F4**) to validate the changes and then exit the system. Select **Save Changes and Reset** to validate the changed BIOS settings and then restart the system

### Discard Changed BIOS Settings

To cancel the BIOS settings you have previously configured, select **Discard Changes and Exit** from this menu, or simply press **Esc** to exit the BIOS setup. You can also select **Discard Changes and Reset** to discard any changes you have made and restore the factory BIOS defaults.

### Load User Defaults

You may simply press **F3** at any time to load the **Optimized Values** which resets all BIOS settings to the factory defaults.

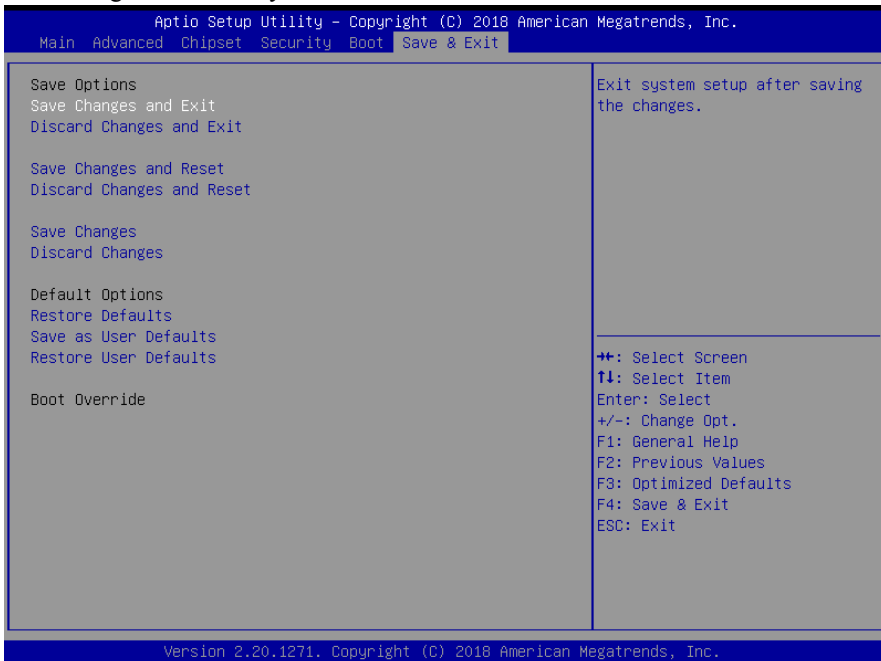

Save & Exit Screen

<b>BIOS Setting</b>	<b>Options</b>	<b>Description/Purpose</b>
Save Changes and Exit	No changeable options	Exits and saves the changes in NVRAM.
Discard Changes and Exit	No changeable options	Exits without saving any changes made in BIOS settings.
Save Changes and Reset	No changeable options	Saves the changes in NVRAM and resets.
Discard Changes and Reset	No changeable options	Resets without saving any changes made in BIOS settings.
Save Changes	No changeable options	Save Changes done so far to any of the setup options.
Discard Changes	No changeable options	Discard Changes done so far to any of the setup options.
Restore Defaults	No changeable options	Loads the optimized defaults for BIOS settings.
Save as User Defaults	No changeable options	Saves the changes done so far as User Defaults.
Restore User Defaults	No changeable options	Restores the User Defaults to all the setup options.
Boot Override	- [Drive(s)]	Forces to boot from selected [drive(s)].

# **Appendix A System Diagrams**

---

---

This appendix provides exploded diagrams and part numbers of SG-S156 / SG-S176 / SG-S216 system.

The following topics are included:

- SG-S156 System Exploded Diagram
- SG-S176 System Exploded Diagram
- SG-S216 System Exploded Diagram
- VESA Mount Assembly Exploded Diagram
- Stand Kit Assembly Exploded Diagram
- SG-S156 Packing Exploded Diagram
- SG-S176 Packing Exploded Diagram
- SG-S216 Packing Exploded Diagram

SG-S156 System Exploded Diagram

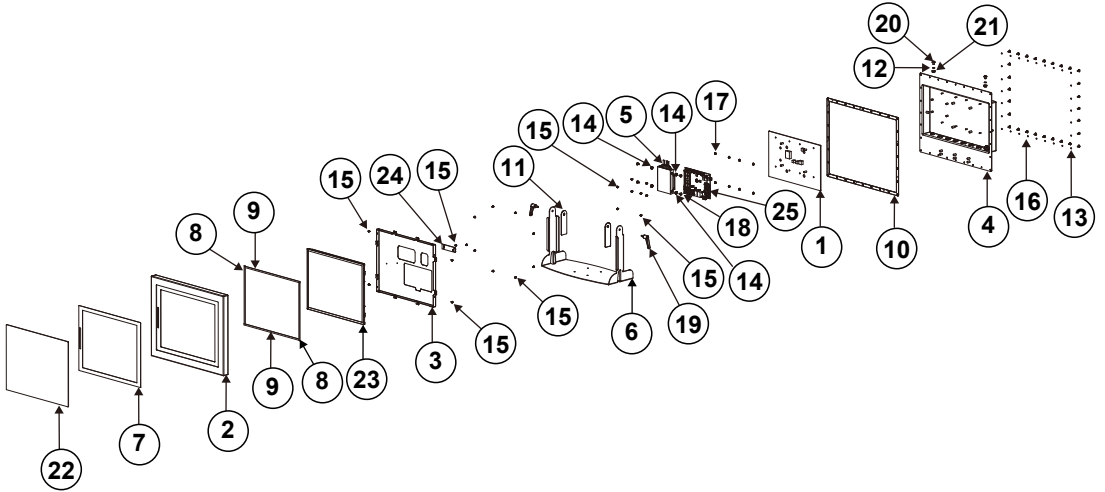

No.	Component Name	P/N No.	Q'ty
1	SG-S151 AL Heat Sink 996 (300x190x3mm)	21-002-10090002	1
Metal (Bracket)			
2	SG-S151 Front Cover Bracket	20-106-07001467	1
3	SG-S151 LCD Bracket	20-106-03001467	1
4	SG-S151 Rear Cover Bracket	20-106-07002467	1
5	SG-S151 HDD Bracket	20-106-03002467	1
6	SG-S151 U STAND	20-117-07001467	1
Rubber / Tape			
7	SG-S151 VHB A2308 Touch Tape (358x272.5x0.8mm)	34-026-05001467	1
8	SP-7755 LCD STRIPS RL (243.3x5.3x0.85mm)	30-013-24100426	2
9	SP-7755 LCD STRIPS TB (317.95x5.3x0.85mm)	30-013-24200426	2
10	SG-S151 Rear Waterproof Silicon Rubber (414x329x1mm)	90-013-01100467	1
11	SG-S151 Stand Mylar (OD= $\varphi$ 15mm, ID= $\varphi$ 8mmx1T)	90-056-39100467	2
12	O-Ring (Black)	30-013-06500000	2
13	SP-7755 Screw O Ring	90-013-06100426	28
14	Rubber Washer (OD= $\varphi$ 9.62mm, ID= $\varphi$ 3.9mmx5.8T) (Blue)	23-680-39580963	4

**Appendix A System Diagrams**

<b>No.</b>	<b>Component Name</b>	<b>P/N No.</b>	<b>Q'ty</b>
Screw / Other Component			
15	Round Head With Spring Washer Screw M3x0.5Px6mm	22-232-30060211	22
16	Fillister Head Screw #2 / M3x0.5Px7mm	22-270-30007011	28
17	SLIP NUTS(M3x0.5P,H=4mm)	23-142-30400801	8
18	Fillister Head Screw M3x0.5Px4.8mm	82-272-30005013	4
19	Adjustable Hand Levers	20-035-35001000	2
20	Truss Head Screw (SUS304) #3 / M6x1.0Px8mm	22-240-60008011	2
21	Slip Nuts (M6x1.0P,H=6mm)	23-142-60601271	2
22	15" 5-Wire Resistive Touch Panel	52-380-00052417	1
	15" Projected Capacitive Touch Panel	52-380-00150517	1
23	LCD Panel	52-351-03016802	1
24	Touch Control Board (available for 5-Wire Resistive Touch Panel)	52-370-01040504	1
25	BE-0996 Main Board	BE-0996RA-D5N / BE-0996RA-D1N	1

SG-S176 System Exploded Diagram

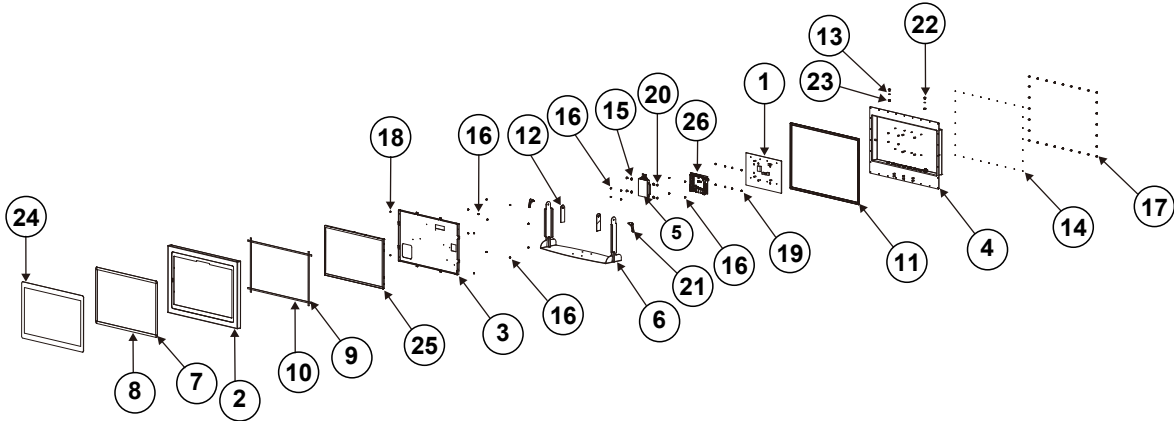

No.	Component Name	P/N No.	Q'ty
1	SG-S151 AL Heat Sink 996 (300x190x3mm)	21-002-10090002	1
Metal (Bracket)			
2	SG-S171 Front Cover Bracket	20-106-07002486	1
3	SG-S171 LCD Bracket	80-106-03001486	1
4	SG-S171 Rear Cover Bracket	20-106-07001486	1
5	SG-S151 HDD Bracket	20-106-03002467	1
6	SG-S171 U Stand	20-217-07001486	1
Rubber / Tape			
7	SP-7147 ABON A-15170-1452 EPDM-H (386.92x30x0.8mm)	34-026-06201412	2
8	SP-7147 ABON A-15170-1452 EPDM-V (271.24x18x0.8mm)	34-026-06202412	2
9	ST-2017 Thin Gap LCD Poron-H (358x8x1mm)	30-013-24100366	2
10	ST-2017 Thin Gap LCD Poron -V (274x8x1mm)	30-013-24200366	2
11	SG-S171 Rear Waterproof Silicon Rubber	30-013-01100486	1
12	SG-S151 Stand Mylar	90-056-39100467	2
13	O-Ring (Black)	30-013-06500000	2
14	SP-7755 Screw O Ring	90-013-06100426	28
15	Rubber Washer (OD= $\varphi$ 9.62mm, ID= $\varphi$ 3.9mmx5.8T) (Blue)	23-680-39580963	4
Screw / Other Component			
16	Round Head With Spring Washer Screw M3x0.5Px6mm	22-232-30060211	22
17	Fillister Head Screw #2 / M3x0.5Px7mm	22-270-30007011	28

*Appendix A System Diagrams*

<b>No.</b>	<b>Component Name</b>	<b>P/N No.</b>	<b>Q'ty</b>
18	Slip Nuts (M3x0.5P, H=4mm)	23-142-30400801	8
19	Fillister Head Screw M3x0.5Px4.8mm	82-272-30005013	4
20	Adjustable Hand Levers	20-035-35001000	2
21	Truss Head Screw (SUS304) #3 / M6x1.0Px8mm	22-240-60008011	2
22	Slip Nuts (M6x1.0P,H=6mm)	23-142-60601271	2
23	17" 5-Wire Resistive Touch Panel	52-380-04211114	1
	17" Projected Capacitive Touch Panel	52-380-04381714	1
24	LCD Panel	52-351-04017002	1
25	Touch Control Board (available for 5-Wire Resistive Touch Panel)	52-370-01405104	1
26	BE-0996 Main Board	BE-0996RA-D5N / BE-0996RA-D1N	1



SG-S216 System Exploded Diagram

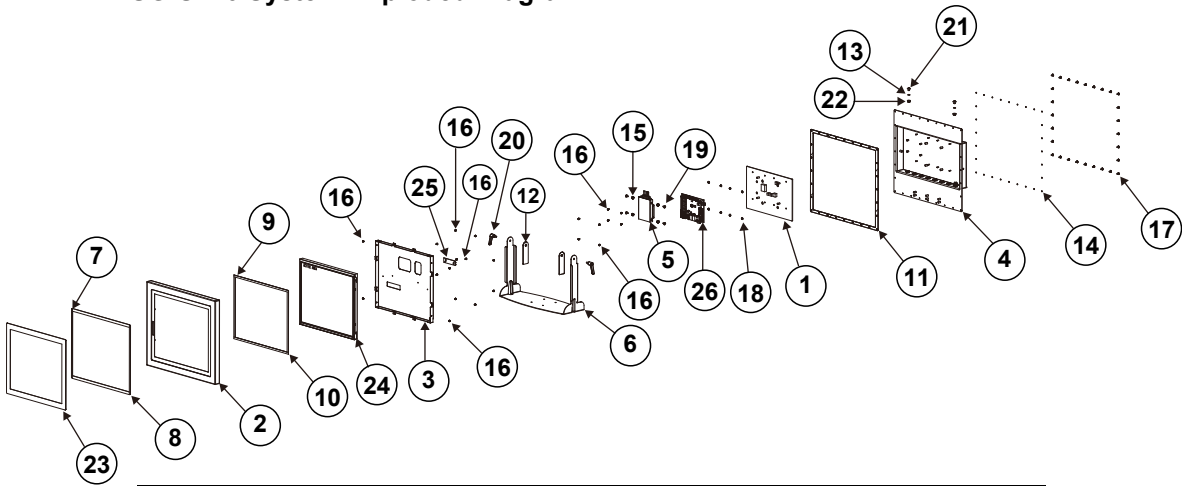

No.	Component Name	P/N No.	Q'ty
1	SG-S151 AL Heat Sink 996 (300x190x3mm)	21-002-10090002	1
Metal (Bracket)			
2	SG-S211 Front Cover Bracket	20-106-07001479	1
3	SG-S211 LCD Bracket	80-106-03001479	1
4	SG-S211 Rear Cover Bracket	20-106-07002479	1
5	SG-S151 HDD Bracket	20-106-03002467	1
6	SG-S211 U Stand	20-217-07001479	1
Rubber / Tape			
7	KS-1132 Touch Panel VHB ELO-S (332x14x1mm)	34-026-05002450	2
8	KS-1132 Touch Panel VHB ELO-L (503x14x1mm)	34-026-05001450	2
9	SP-S214 Touch Thin Gap EPDM V (318x7x2mm)	30-013-01100454	2
10	SP-S214 Touch Thin Gap EPDM H (540x7x2mm)	30-013-01200454	2
11	SG-S211 Rear Waterproof Silicon Rubber (584x389x1mm)	30-013-01100479	1
12	SG-S151 Stand Mylar	90-056-39100467	2
13	O-Ring (Black)	30-013-06500000	2
14	SP-7755 Screw O Ring	90-013-06100426	28
15	Rubber Washer (OD= $\varphi$ 9.62mm, ID= $\varphi$ 3.9mmx5.8T) (Blue)	23-680-39580963	4
Screw / Other Component			
16	Round Head With Spring Washer Screw M3x0.5Px6mm	22-232-30060211	22
17	Fillister Head Screw #2 / M3x0.5Px7mm	22-270-30007011	28

<b>No.</b>	<b>Component Name</b>	<b>P/N No.</b>	<b>Q'ty</b>
18	Round Washer Head Screw #2 / M3x0.5Px3mm	22-235-30003011	4
19	SLIP NUTS(M3x0.5P,H=4mm)	23-142-30400801	8
20	Fillister Head Screw M3x0.5Px4.8mm	82-272-30005013	4
21	Adjustable Hand Levers	20-035-35001000	2
22	Truss Head Screw (SUS304) #3 / M6x1.0Px8mm	22-240-60008011	2
23	Slip Nuts (M6x1.0P, H=6mm)	23-142-60601271	2
24	21.5" 5-Wire Resistive Touch Panel	N/A	1
	21.5" Capacitive Touch Panel	52-380-13795701	1
25	21.5" TFT LCD Panel(LED Backlight),350nits(1920x1080)	52-351-13215202	1
26	BE-0996 Main Board	BE-0996RA-D5N / BE-0996RA-D1N	1

## VESA Mount Installation Exploded Diagram

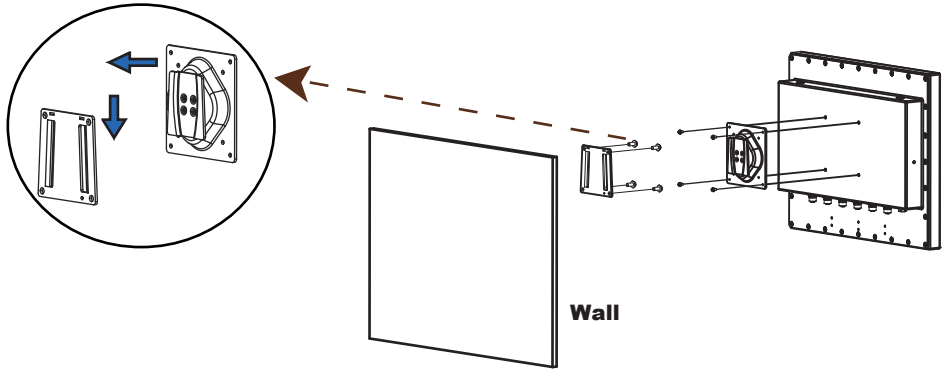

## Stand Kit Installation Exploded Diagram

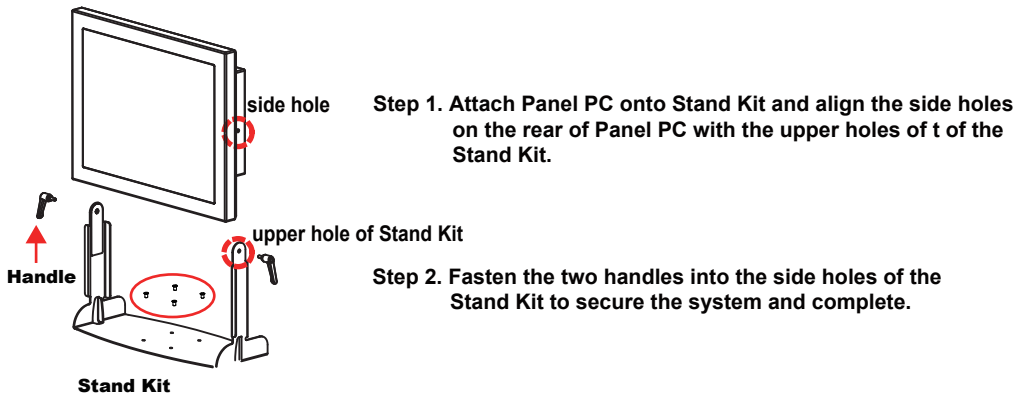

## Stand Installation Accessories

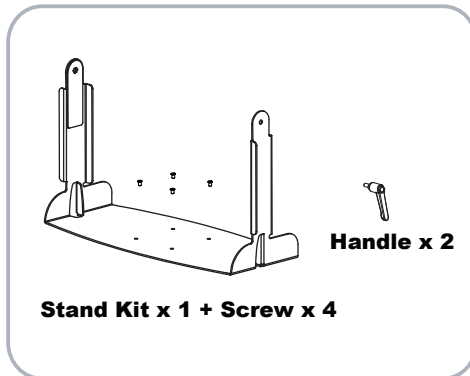

**SG-S156 Packing Exploded Diagram**

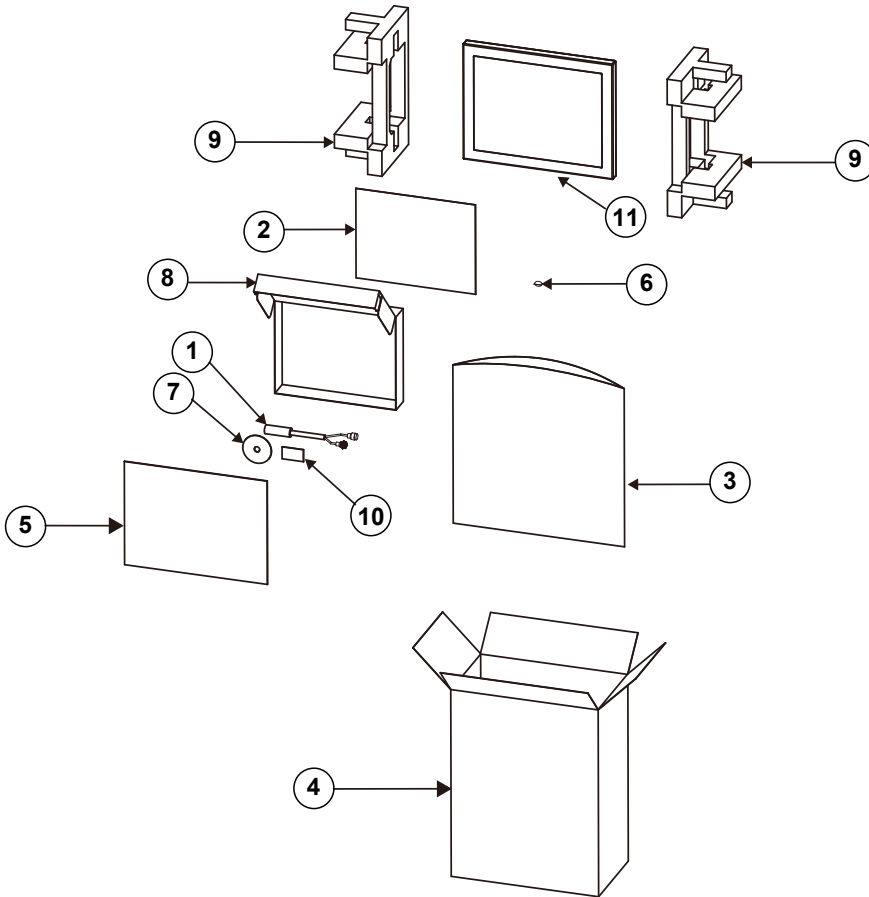

No.	Component Name	P/N No.	Q'ty
1	SP-7755 Power Cable ( L=1800mm)	27-019-42636111	1
2	Mylar 335x260x0.125mm	30-056-02100008	1
3	PE Bag 480X460 (42X56CMx0.07)	32-10020010000	1
4	MH-5100-VR Plastic Box Outer Carton (543x413x243mm)	34-001-01401378	1
5	Card Board (400x300)	34-004-01301008	1
6	Silica Gel 1gm	34-005-00010007	2
7	DVD-R(w/Protech logo) For OBM	52-601-02000005	1
8	PT-1920 Carton Boxes (340x278x60mm)	94-003-01301318	1
9	SG-S151 EPE (397x218x133mm)	94-016-00301467	2
10	SG-S156 Rating Label (60x35mm)	94-017-01601470	1
11	SG-S156	N/A	1

**SG-S176 Packing Exploded Diagram**

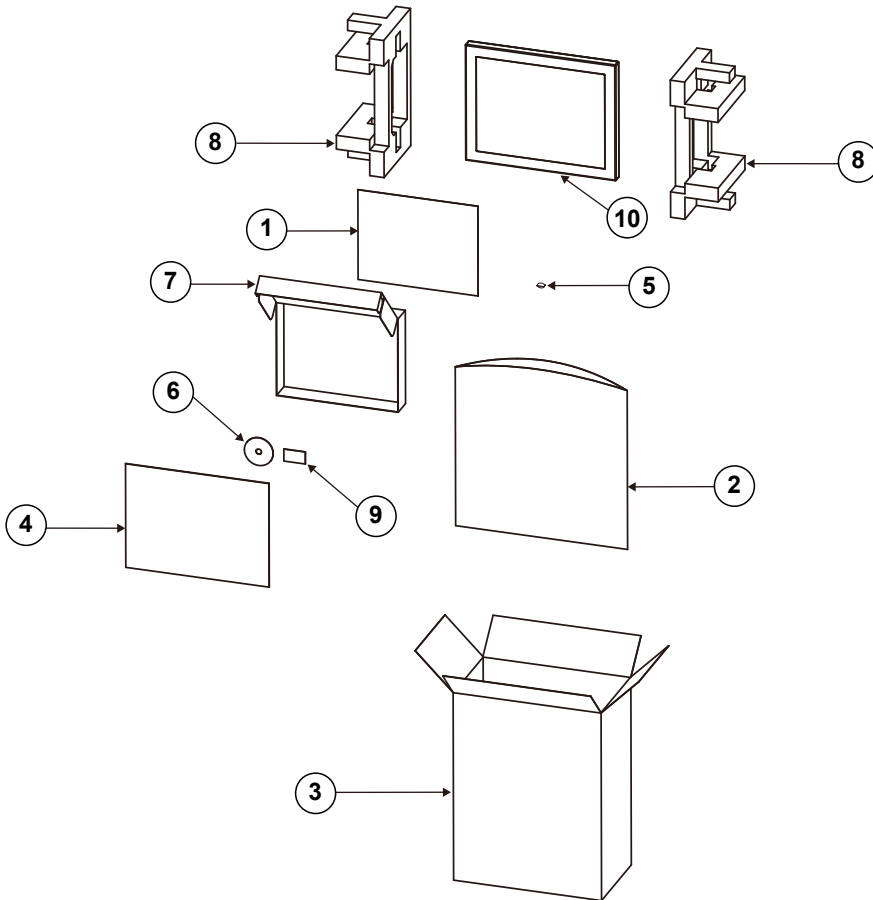

No.	Component Name	P/N No.	Q'ty
1	Mylar 335x260x0.125	30-056-02100008	1
2	PE Bag 870x670x0.07mm	34-010-00210003	1
3	MM-7017R Basic Style Outer Carton (532x487x203mm)	94-001-01401258	1
4	Card Board (400x300)	34-004-01301008	1
5	SILICA GEL 1gm	34-005-00010007	2
6	DVD-R (w/Protech logo) For OBM	52-601-02000005	1
7	PT-1920 Carton Boxes (340x278x60mm)	94-003-01301318	1
8	SG-S171 PPC EPE (475x185x192mm)	94-016-00304486	2
9	Electroforming Paster ("Prox" Logo L)	34-017-02201000	1
10	SG-S176	N/A	1

**SG-S216 Packing Exploded Diagram**

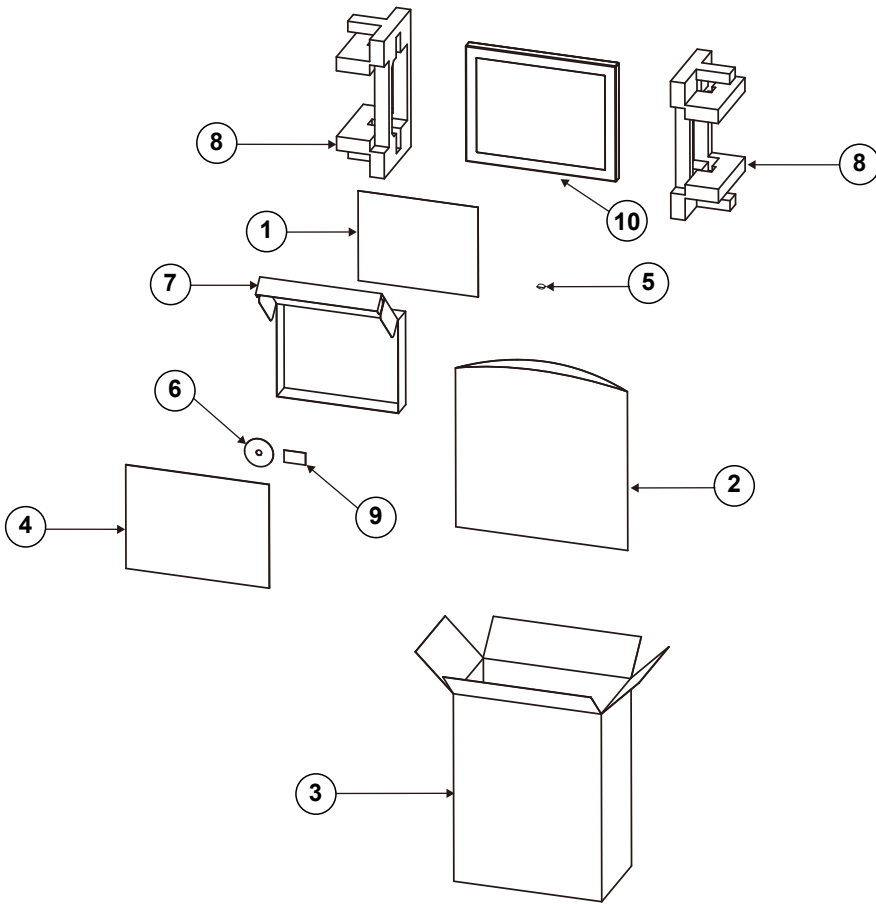

No.	Component Name	P/N No.	Q'ty
1	Mylar 335x260x0.125	30-056-02100008	1
2	PE Bag 870x670x0.07mm	34-010-00210003	1
3	SG-S211 Outer Carton (680x490x200mm)	94-001-01401479	1
4	Card Board (400x300)	34-004-01301008	1
5	SILICA GEL 1gm	34-005-00010007	2
6	DVD-R (w/Protech logo) For OBM	52-601-02000005	1
7	PT-1920 Carton Boxes (340x278x60mm)	94-003-01301318	1
8	SG-S211 PPC EPE (475x185x192mm)	94-016-00304479	2
9	Electroforming Paster ("Prox" Logo L)	34-017-02201000	1
10	SG-S216	N/A	1

## **Appendix B Technical Summary**

This appendix will give you a brief introduction of the allocation maps for SG-S156 resources.

The following topics are included:

- BE-0996 Block Diagram
- Interrupt Map
- I/O Map
- Memory Map
- Configuring WatchDog Timer
- Flash BIOS Update



## BE-0996 Block Diagram

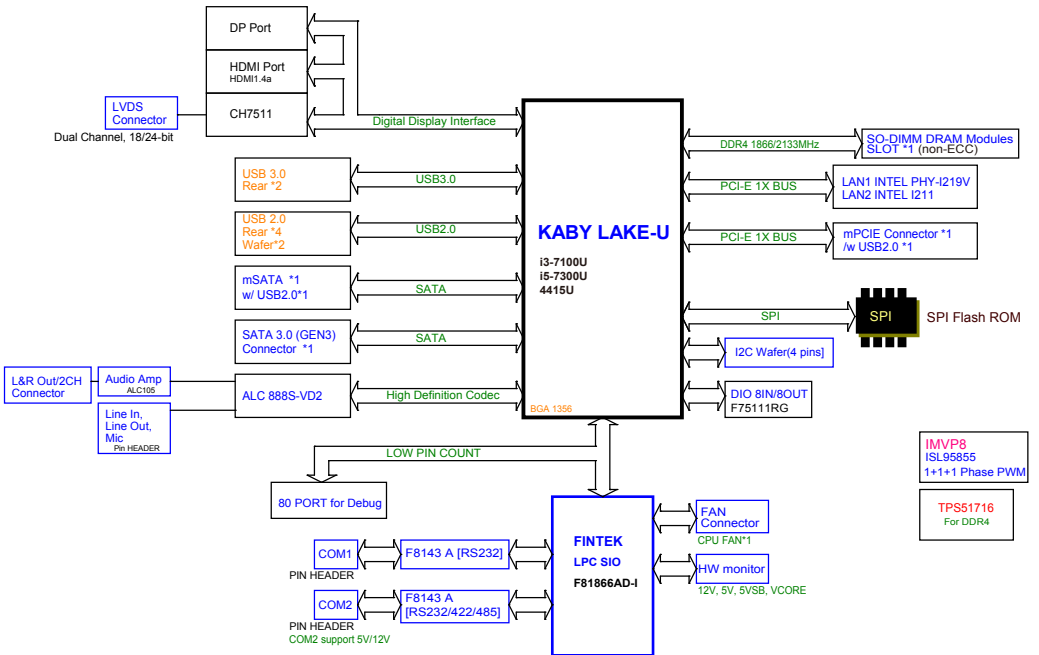

## Interrupt Map

IRQ	Assignment
IRQ 0	System timer
IRQ 3	Communications Port (COM2)
IRQ 4	Communications Port (COM1)
IRQ 8	System CMOS/real time clock
IRQ 14	Motherboard resources
IRQ 16	Intel(R) Serial IO I2C Host Controller - 9D60
IRQ 20	Intel(R) Serial IO UART Host Controller - 9D27
IRQ 54	Microsoft ACPI-Compliant System
IRQ 55	Microsoft ACPI-Compliant System
IRQ 56	Microsoft ACPI-Compliant System
IRQ 57	Microsoft ACPI-Compliant System
IRQ 58	Microsoft ACPI-Compliant System
IRQ 59	Microsoft ACPI-Compliant System
IRQ 60	Microsoft ACPI-Compliant System
IRQ 61	Microsoft ACPI-Compliant System
IRQ 62	Microsoft ACPI-Compliant System
IRQ 63	Microsoft ACPI-Compliant System
IRQ 64	Microsoft ACPI-Compliant System
IRQ 65	Microsoft ACPI-Compliant System
IRQ 66	Microsoft ACPI-Compliant System
IRQ 67	Microsoft ACPI-Compliant System
IRQ 68	Microsoft ACPI-Compliant System
IRQ 69	Microsoft ACPI-Compliant System
IRQ 70	Microsoft ACPI-Compliant System
IRQ 71	Microsoft ACPI-Compliant System

<b>IRQ</b>	<b>Assignment</b>
IRQ 72	Microsoft ACPI-Compliant System
IRQ 73	Microsoft ACPI-Compliant System
IRQ 74	Microsoft ACPI-Compliant System
IRQ 75	Microsoft ACPI-Compliant System
IRQ 76	Microsoft ACPI-Compliant System
IRQ 77	Microsoft ACPI-Compliant System
IRQ 78	Microsoft ACPI-Compliant System
IRQ 79	Microsoft ACPI-Compliant System
IRQ 80	Microsoft ACPI-Compliant System
IRQ 81	Microsoft ACPI-Compliant System
IRQ 82	Microsoft ACPI-Compliant System
IRQ 83	Microsoft ACPI-Compliant System
IRQ 84	Microsoft ACPI-Compliant System
IRQ 85	Microsoft ACPI-Compliant System
IRQ 86	Microsoft ACPI-Compliant System
IRQ 87	Microsoft ACPI-Compliant System
IRQ 88	Microsoft ACPI-Compliant System
IRQ 89	Microsoft ACPI-Compliant System
IRQ 90	Microsoft ACPI-Compliant System
IRQ 91	Microsoft ACPI-Compliant System
IRQ 92	Microsoft ACPI-Compliant System
IRQ 93	Microsoft ACPI-Compliant System
IRQ 94	Microsoft ACPI-Compliant System
IRQ 95	Microsoft ACPI-Compliant System
IRQ 96	Microsoft ACPI-Compliant System
IRQ 97	Microsoft ACPI-Compliant System
IRQ 98	Microsoft ACPI-Compliant System

<b>IRQ</b>	<b>Assignment</b>
IRQ 99	Microsoft ACPI-Compliant System
IRQ 100	Microsoft ACPI-Compliant System
IRQ 101	Microsoft ACPI-Compliant System
IRQ 102	Microsoft ACPI-Compliant System
IRQ 103	Microsoft ACPI-Compliant System
IRQ 104	Microsoft ACPI-Compliant System
IRQ 105	Microsoft ACPI-Compliant System
IRQ 106	Microsoft ACPI-Compliant System
IRQ 107	Microsoft ACPI-Compliant System
IRQ 108	Microsoft ACPI-Compliant System
IRQ 109	Microsoft ACPI-Compliant System
IRQ 110	Microsoft ACPI-Compliant System
IRQ 111	Microsoft ACPI-Compliant System
IRQ 112	Microsoft ACPI-Compliant System
IRQ 113	Microsoft ACPI-Compliant System
IRQ 114	Microsoft ACPI-Compliant System
IRQ 115	Microsoft ACPI-Compliant System
IRQ 116	Microsoft ACPI-Compliant System
IRQ 117	Microsoft ACPI-Compliant System
IRQ 118	Microsoft ACPI-Compliant System
IRQ 119	Microsoft ACPI-Compliant System
IRQ 120	Microsoft ACPI-Compliant System
IRQ 121	Microsoft ACPI-Compliant System
IRQ 122	Microsoft ACPI-Compliant System
IRQ 123	Microsoft ACPI-Compliant System
IRQ 124	Microsoft ACPI-Compliant System
IRQ 125	Microsoft ACPI-Compliant System

<b>IRQ</b>	<b>Assignment</b>
IRQ 126	Microsoft ACPI-Compliant System
IRQ 127	Microsoft ACPI-Compliant System
IRQ 128	Microsoft ACPI-Compliant System
IRQ 129	Microsoft ACPI-Compliant System
IRQ 130	Microsoft ACPI-Compliant System
IRQ 131	Microsoft ACPI-Compliant System
IRQ 132	Microsoft ACPI-Compliant System
IRQ 133	Microsoft ACPI-Compliant System
IRQ 134	Microsoft ACPI-Compliant System
IRQ 135	Microsoft ACPI-Compliant System
IRQ 136	Microsoft ACPI-Compliant System
IRQ 137	Microsoft ACPI-Compliant System
IRQ 138	Microsoft ACPI-Compliant System
IRQ 139	Microsoft ACPI-Compliant System
IRQ 140	Microsoft ACPI-Compliant System
IRQ 141	Microsoft ACPI-Compliant System
IRQ 142	Microsoft ACPI-Compliant System
IRQ 143	Microsoft ACPI-Compliant System
IRQ 144	Microsoft ACPI-Compliant System
IRQ 145	Microsoft ACPI-Compliant System
IRQ 146	Microsoft ACPI-Compliant System
IRQ 147	Microsoft ACPI-Compliant System
IRQ 148	Microsoft ACPI-Compliant System
IRQ 149	Microsoft ACPI-Compliant System
IRQ 150	Microsoft ACPI-Compliant System
IRQ 151	Microsoft ACPI-Compliant System
IRQ 152	Microsoft ACPI-Compliant System

<b>IRQ</b>	<b>Assignment</b>
IRQ 153	Microsoft ACPI-Compliant System
IRQ 154	Microsoft ACPI-Compliant System
IRQ 155	Microsoft ACPI-Compliant System
IRQ 156	Microsoft ACPI-Compliant System
IRQ 157	Microsoft ACPI-Compliant System
IRQ 158	Microsoft ACPI-Compliant System
IRQ 159	Microsoft ACPI-Compliant System
IRQ 160	Microsoft ACPI-Compliant System
IRQ 161	Microsoft ACPI-Compliant System
IRQ 162	Microsoft ACPI-Compliant System
IRQ 163	Microsoft ACPI-Compliant System
IRQ 164	Microsoft ACPI-Compliant System
IRQ 165	Microsoft ACPI-Compliant System
IRQ 166	Microsoft ACPI-Compliant System
IRQ 167	Microsoft ACPI-Compliant System
IRQ 168	Microsoft ACPI-Compliant System
IRQ 169	Microsoft ACPI-Compliant System
IRQ 170	Microsoft ACPI-Compliant System
IRQ 171	Microsoft ACPI-Compliant System
IRQ 172	Microsoft ACPI-Compliant System
IRQ 173	Microsoft ACPI-Compliant System
IRQ 174	Microsoft ACPI-Compliant System
IRQ 175	Microsoft ACPI-Compliant System
IRQ 176	Microsoft ACPI-Compliant System
IRQ 177	Microsoft ACPI-Compliant System
IRQ 178	Microsoft ACPI-Compliant System
IRQ 179	Microsoft ACPI-Compliant System

<b>IRQ</b>	<b>Assignment</b>
IRQ 180	Microsoft ACPI-Compliant System
IRQ 181	Microsoft ACPI-Compliant System
IRQ 182	Microsoft ACPI-Compliant System
IRQ 183	Microsoft ACPI-Compliant System
IRQ 184	Microsoft ACPI-Compliant System
IRQ 185	Microsoft ACPI-Compliant System
IRQ 186	Microsoft ACPI-Compliant System
IRQ 187	Microsoft ACPI-Compliant System
IRQ 188	Microsoft ACPI-Compliant System
IRQ 189	Microsoft ACPI-Compliant System
IRQ 190	Microsoft ACPI-Compliant System
IRQ 191	Microsoft ACPI-Compliant System
IRQ 192	Microsoft ACPI-Compliant System
IRQ 193	Microsoft ACPI-Compliant System
IRQ 194	Microsoft ACPI-Compliant System
IRQ 195	Microsoft ACPI-Compliant System
IRQ 196	Microsoft ACPI-Compliant System
IRQ 197	Microsoft ACPI-Compliant System
IRQ 198	Microsoft ACPI-Compliant System
IRQ 199	Microsoft ACPI-Compliant System
IRQ 200	Microsoft ACPI-Compliant System
IRQ 201	Microsoft ACPI-Compliant System
IRQ 202	Microsoft ACPI-Compliant System
IRQ 203	Microsoft ACPI-Compliant System
IRQ 204	Microsoft ACPI-Compliant System
IRQ 256	Microsoft ACPI-Compliant System
IRQ 257	Microsoft ACPI-Compliant System

<b>IRQ</b>	<b>Assignment</b>
IRQ 258	Microsoft ACPI-Compliant System
IRQ 259	Microsoft ACPI-Compliant System
IRQ 260	Microsoft ACPI-Compliant System
IRQ 261	Microsoft ACPI-Compliant System
IRQ 262	Microsoft ACPI-Compliant System
IRQ 263	Microsoft ACPI-Compliant System
IRQ 264	Microsoft ACPI-Compliant System
IRQ 265	Microsoft ACPI-Compliant System
IRQ 266	Microsoft ACPI-Compliant System
IRQ 267	Microsoft ACPI-Compliant System
IRQ 268	Microsoft ACPI-Compliant System
IRQ 269	Microsoft ACPI-Compliant System
IRQ 270	Microsoft ACPI-Compliant System
IRQ 271	Microsoft ACPI-Compliant System
IRQ 272	Microsoft ACPI-Compliant System
IRQ 273	Microsoft ACPI-Compliant System
IRQ 274	Microsoft ACPI-Compliant System
IRQ 275	Microsoft ACPI-Compliant System
IRQ 276	Microsoft ACPI-Compliant System
IRQ 277	Microsoft ACPI-Compliant System
IRQ 278	Microsoft ACPI-Compliant System
IRQ 279	Microsoft ACPI-Compliant System
IRQ 280	Microsoft ACPI-Compliant System
IRQ 281	Microsoft ACPI-Compliant System
IRQ 282	Microsoft ACPI-Compliant System
IRQ 283	Microsoft ACPI-Compliant System
IRQ 284	Microsoft ACPI-Compliant System



<b>IRQ</b>	<b>Assignment</b>
IRQ 285	Microsoft ACPI-Compliant System
IRQ 286	Microsoft ACPI-Compliant System
IRQ 287	Microsoft ACPI-Compliant System
IRQ 288	Microsoft ACPI-Compliant System
IRQ 289	Microsoft ACPI-Compliant System
IRQ 290	Microsoft ACPI-Compliant System
IRQ 291	Microsoft ACPI-Compliant System
IRQ 292	Microsoft ACPI-Compliant System
IRQ 293	Microsoft ACPI-Compliant System
IRQ 294	Microsoft ACPI-Compliant System
IRQ 295	Microsoft ACPI-Compliant System
IRQ 296	Microsoft ACPI-Compliant System
IRQ 297	Microsoft ACPI-Compliant System
IRQ 298	Microsoft ACPI-Compliant System
IRQ 299	Microsoft ACPI-Compliant System
IRQ 300	Microsoft ACPI-Compliant System
IRQ 301	Microsoft ACPI-Compliant System
IRQ 302	Microsoft ACPI-Compliant System
IRQ 303	Microsoft ACPI-Compliant System
IRQ 304	Microsoft ACPI-Compliant System
IRQ 305	Microsoft ACPI-Compliant System
IRQ 306	Microsoft ACPI-Compliant System
IRQ 307	Microsoft ACPI-Compliant System
IRQ 308	Microsoft ACPI-Compliant System
IRQ 309	Microsoft ACPI-Compliant System
IRQ 310	Microsoft ACPI-Compliant System
IRQ 311	Microsoft ACPI-Compliant System

<b>IRQ</b>	<b>Assignment</b>
IRQ 312	Microsoft ACPI-Compliant System
IRQ 313	Microsoft ACPI-Compliant System
IRQ 314	Microsoft ACPI-Compliant System
IRQ 315	Microsoft ACPI-Compliant System
IRQ 316	Microsoft ACPI-Compliant System
IRQ 317	Microsoft ACPI-Compliant System
IRQ 318	Microsoft ACPI-Compliant System
IRQ 319	Microsoft ACPI-Compliant System
IRQ 320	Microsoft ACPI-Compliant System
IRQ 321	Microsoft ACPI-Compliant System
IRQ 322	Microsoft ACPI-Compliant System
IRQ 323	Microsoft ACPI-Compliant System
IRQ 324	Microsoft ACPI-Compliant System
IRQ 325	Microsoft ACPI-Compliant System
IRQ 326	Microsoft ACPI-Compliant System
IRQ 327	Microsoft ACPI-Compliant System
IRQ 328	Microsoft ACPI-Compliant System
IRQ 329	Microsoft ACPI-Compliant System
IRQ 330	Microsoft ACPI-Compliant System
IRQ 331	Microsoft ACPI-Compliant System
IRQ 332	Microsoft ACPI-Compliant System
IRQ 333	Microsoft ACPI-Compliant System
IRQ 334	Microsoft ACPI-Compliant System
IRQ 335	Microsoft ACPI-Compliant System
IRQ 336	Microsoft ACPI-Compliant System
IRQ 337	Microsoft ACPI-Compliant System
IRQ 338	Microsoft ACPI-Compliant System

<b>IRQ</b>	<b>Assignment</b>
IRQ 339	Microsoft ACPI-Compliant System
IRQ 340	Microsoft ACPI-Compliant System
IRQ 341	Microsoft ACPI-Compliant System
IRQ 342	Microsoft ACPI-Compliant System
IRQ 343	Microsoft ACPI-Compliant System
IRQ 344	Microsoft ACPI-Compliant System
IRQ 345	Microsoft ACPI-Compliant System
IRQ 346	Microsoft ACPI-Compliant System
IRQ 347	Microsoft ACPI-Compliant System
IRQ 348	Microsoft ACPI-Compliant System
IRQ 349	Microsoft ACPI-Compliant System
IRQ 350	Microsoft ACPI-Compliant System
IRQ 351	Microsoft ACPI-Compliant System
IRQ 352	Microsoft ACPI-Compliant System
IRQ 353	Microsoft ACPI-Compliant System
IRQ 354	Microsoft ACPI-Compliant System
IRQ 355	Microsoft ACPI-Compliant System
IRQ 356	Microsoft ACPI-Compliant System
IRQ 357	Microsoft ACPI-Compliant System
IRQ 358	Microsoft ACPI-Compliant System
IRQ 359	Microsoft ACPI-Compliant System
IRQ 360	Microsoft ACPI-Compliant System
IRQ 361	Microsoft ACPI-Compliant System
IRQ 362	Microsoft ACPI-Compliant System
IRQ 363	Microsoft ACPI-Compliant System
IRQ 364	Microsoft ACPI-Compliant System
IRQ 365	Microsoft ACPI-Compliant System

<b>IRQ</b>	<b>Assignment</b>
IRQ 366	Microsoft ACPI-Compliant System
IRQ 367	Microsoft ACPI-Compliant System
IRQ 368	Microsoft ACPI-Compliant System
IRQ 369	Microsoft ACPI-Compliant System
IRQ 370	Microsoft ACPI-Compliant System
IRQ 371	Microsoft ACPI-Compliant System
IRQ 372	Microsoft ACPI-Compliant System
IRQ 373	Microsoft ACPI-Compliant System
IRQ 374	Microsoft ACPI-Compliant System
IRQ 375	Microsoft ACPI-Compliant System
IRQ 376	Microsoft ACPI-Compliant System
IRQ 377	Microsoft ACPI-Compliant System
IRQ 378	Microsoft ACPI-Compliant System
IRQ 379	Microsoft ACPI-Compliant System
IRQ 380	Microsoft ACPI-Compliant System
IRQ 381	Microsoft ACPI-Compliant System
IRQ 382	Microsoft ACPI-Compliant System
IRQ 383	Microsoft ACPI-Compliant System
IRQ 384	Microsoft ACPI-Compliant System
IRQ 385	Microsoft ACPI-Compliant System
IRQ 386	Microsoft ACPI-Compliant System
IRQ 387	Microsoft ACPI-Compliant System
IRQ 388	Microsoft ACPI-Compliant System
IRQ 389	Microsoft ACPI-Compliant System
IRQ 390	Microsoft ACPI-Compliant System
IRQ 391	Microsoft ACPI-Compliant System
IRQ 392	Microsoft ACPI-Compliant System

<b>IRQ</b>	<b>Assignment</b>
IRQ 393	Microsoft ACPI-Compliant System
IRQ 394	Microsoft ACPI-Compliant System
IRQ 395	Microsoft ACPI-Compliant System
IRQ 396	Microsoft ACPI-Compliant System
IRQ 397	Microsoft ACPI-Compliant System
IRQ 398	Microsoft ACPI-Compliant System
IRQ 399	Microsoft ACPI-Compliant System
IRQ 400	Microsoft ACPI-Compliant System
IRQ 401	Microsoft ACPI-Compliant System
IRQ 402	Microsoft ACPI-Compliant System
IRQ 403	Microsoft ACPI-Compliant System
IRQ 404	Microsoft ACPI-Compliant System
IRQ 405	Microsoft ACPI-Compliant System
IRQ 406	Microsoft ACPI-Compliant System
IRQ 407	Microsoft ACPI-Compliant System
IRQ 408	Microsoft ACPI-Compliant System
IRQ 409	Microsoft ACPI-Compliant System
IRQ 410	Microsoft ACPI-Compliant System
IRQ 411	Microsoft ACPI-Compliant System
IRQ 412	Microsoft ACPI-Compliant System
IRQ 413	Microsoft ACPI-Compliant System
IRQ 414	Microsoft ACPI-Compliant System
IRQ 415	Microsoft ACPI-Compliant System
IRQ 416	Microsoft ACPI-Compliant System
IRQ 417	Microsoft ACPI-Compliant System
IRQ 418	Microsoft ACPI-Compliant System
IRQ 419	Microsoft ACPI-Compliant System

<b>IRQ</b>	<b>Assignment</b>
IRQ 420	Microsoft ACPI-Compliant System
IRQ 421	Microsoft ACPI-Compliant System
IRQ 422	Microsoft ACPI-Compliant System
IRQ 423	Microsoft ACPI-Compliant System
IRQ 424	Microsoft ACPI-Compliant System
IRQ 425	Microsoft ACPI-Compliant System
IRQ 426	Microsoft ACPI-Compliant System
IRQ 427	Microsoft ACPI-Compliant System
IRQ 428	Microsoft ACPI-Compliant System
IRQ 429	Microsoft ACPI-Compliant System
IRQ 430	Microsoft ACPI-Compliant System
IRQ 431	Microsoft ACPI-Compliant System
IRQ 432	Microsoft ACPI-Compliant System
IRQ 433	Microsoft ACPI-Compliant System
IRQ 434	Microsoft ACPI-Compliant System
IRQ 435	Microsoft ACPI-Compliant System
IRQ 436	Microsoft ACPI-Compliant System
IRQ 437	Microsoft ACPI-Compliant System
IRQ 438	Microsoft ACPI-Compliant System
IRQ 439	Microsoft ACPI-Compliant System
IRQ 440	Microsoft ACPI-Compliant System
IRQ 441	Microsoft ACPI-Compliant System
IRQ 442	Microsoft ACPI-Compliant System
IRQ 443	Microsoft ACPI-Compliant System
IRQ 444	Microsoft ACPI-Compliant System
IRQ 445	Microsoft ACPI-Compliant System
IRQ 446	Microsoft ACPI-Compliant System

<b>IRQ</b>	<b>Assignment</b>
IRQ 447	Microsoft ACPI-Compliant System
IRQ 448	Microsoft ACPI-Compliant System
IRQ 449	Microsoft ACPI-Compliant System
IRQ 450	Microsoft ACPI-Compliant System
IRQ 451	Microsoft ACPI-Compliant System
IRQ 452	Microsoft ACPI-Compliant System
IRQ 453	Microsoft ACPI-Compliant System
IRQ 454	Microsoft ACPI-Compliant System
IRQ 455	Microsoft ACPI-Compliant System
IRQ 456	Microsoft ACPI-Compliant System
IRQ 457	Microsoft ACPI-Compliant System
IRQ 458	Microsoft ACPI-Compliant System
IRQ 459	Microsoft ACPI-Compliant System
IRQ 460	Microsoft ACPI-Compliant System
IRQ 461	Microsoft ACPI-Compliant System
IRQ 462	Microsoft ACPI-Compliant System
IRQ 463	Microsoft ACPI-Compliant System
IRQ 464	Microsoft ACPI-Compliant System
IRQ 465	Microsoft ACPI-Compliant System
IRQ 466	Microsoft ACPI-Compliant System
IRQ 467	Microsoft ACPI-Compliant System
IRQ 468	Microsoft ACPI-Compliant System
IRQ 469	Microsoft ACPI-Compliant System
IRQ 470	Microsoft ACPI-Compliant System
IRQ 471	Microsoft ACPI-Compliant System
IRQ 472	Microsoft ACPI-Compliant System
IRQ 473	Microsoft ACPI-Compliant System

<b>IRQ</b>	<b>Assignment</b>
IRQ 474	Microsoft ACPI-Compliant System
IRQ 475	Microsoft ACPI-Compliant System
IRQ 476	Microsoft ACPI-Compliant System
IRQ 477	Microsoft ACPI-Compliant System
IRQ 478	Microsoft ACPI-Compliant System
IRQ 479	Microsoft ACPI-Compliant System
IRQ 480	Microsoft ACPI-Compliant System
IRQ 481	Microsoft ACPI-Compliant System
IRQ 482	Microsoft ACPI-Compliant System
IRQ 483	Microsoft ACPI-Compliant System
IRQ 484	Microsoft ACPI-Compliant System
IRQ 485	Microsoft ACPI-Compliant System
IRQ 486	Microsoft ACPI-Compliant System
IRQ 487	Microsoft ACPI-Compliant System
IRQ 488	Microsoft ACPI-Compliant System
IRQ 489	Microsoft ACPI-Compliant System
IRQ 490	Microsoft ACPI-Compliant System
IRQ 491	Microsoft ACPI-Compliant System
IRQ 492	Microsoft ACPI-Compliant System
IRQ 493	Microsoft ACPI-Compliant System
IRQ 494	Microsoft ACPI-Compliant System
IRQ 495	Microsoft ACPI-Compliant System
IRQ 496	Microsoft ACPI-Compliant System
IRQ 497	Microsoft ACPI-Compliant System
IRQ 498	Microsoft ACPI-Compliant System
IRQ 499	Microsoft ACPI-Compliant System
IRQ 500	Microsoft ACPI-Compliant System



<b>IRQ</b>	<b>Assignment</b>
IRQ 501	Microsoft ACPI-Compliant System
IRQ 502	Microsoft ACPI-Compliant System
IRQ 503	Microsoft ACPI-Compliant System
IRQ 504	Microsoft ACPI-Compliant System
IRQ 505	Microsoft ACPI-Compliant System
IRQ 506	Microsoft ACPI-Compliant System
IRQ 507	Microsoft ACPI-Compliant System
IRQ 508	Microsoft ACPI-Compliant System
IRQ 509	Microsoft ACPI-Compliant System
IRQ 510	Microsoft ACPI-Compliant System
IRQ 511	Microsoft ACPI-Compliant System
IRQ 4294967286	Intel(R) Management Engine Interface
IRQ 4294967287	Intel(R) Ethernet Connection I219-V
IRQ 4294967288	Intel(R) HD Graphics 620
IRQ 4294967289	Intel(R) USB 3.0 eXtensible Host Controller - 1.0 (Microsoft)
IRQ 4294967290	Intel(R) I211 Gigabit Network Connection
IRQ 4294967291	Intel(R) I211 Gigabit Network Connection
IRQ 4294967292	Intel(R) I211 Gigabit Network Connection
IRQ 4294967293	Intel(R) I211 Gigabit Network Connection
IRQ 4294967294	Standard SATA AHCI Controller

**Note:** These resource information were gathered using Windows 10.

## I/O MAP

I/O Map	Assignment
0x00000000-0x00000CF7	PCI Express Root Complex
0x00000020-0x00000021	Programmable interrupt controller
0x00000024-0x00000025	Programmable interrupt controller
0x00000028-0x00000029	Programmable interrupt controller
0x0000002C-0x0000002D	Programmable interrupt controller
0x0000002E-0x0000002F	Motherboard resources
0x00000030-0x00000031	Programmable interrupt controller
0x00000034-0x00000035	Programmable interrupt controller
0x00000038-0x00000039	Programmable interrupt controller
0x0000003C-0x0000003D	Programmable interrupt controller
0x00000040-0x00000043	System timer
0x0000004E-0x0000004F	Motherboard resources
0x00000050-0x00000053	System timer
0x00000061-0x00000061	Motherboard resources
0x00000063-0x00000063	Motherboard resources
0x00000065-0x00000065	Motherboard resources
0x00000067-0x00000067	Motherboard resources
0x00000070-0x00000070	Motherboard resources
0x00000070-0x00000070	System CMOS/real time clock
0x00000080-0x00000080	Motherboard resources
0x00000092-0x00000092	Motherboard resources
0x000000A0-0x000000A1	Programmable interrupt controller
0x000000A4-0x000000A5	Programmable interrupt controller
0x000000A8-0x000000A9	Programmable interrupt controller
0x000000AC-0x000000AD	Programmable interrupt controller
0x000000B0-0x000000B1	Programmable interrupt controller
0x000000B2-0x000000B3	Motherboard resources
0x000000B4-0x000000B5	Programmable interrupt controller

<b>I/O Map</b>	<b>Assignment</b>
0x000000B8-0x000000B9	Programmable interrupt controller
0x000000BC-0x000000BD	Programmable interrupt controller
0x000002F8-0x000002FF	Communications Port (COM2)
0x000003F8-0x000003FF	Communications Port (COM1)
0x000004D0-0x000004D1	Programmable interrupt controller
0x00000680-0x0000069F	Motherboard resources
0x00000A00-0x00000A0F	Motherboard resources
0x00000A10-0x00000A1F	Motherboard resources
0x00000A20-0x00000A2F	Motherboard resources
0x00000D00-0x0000FFFF	PCI Express Root Complex
0x0000164E-0x0000164F	Motherboard resources
0x00001800-0x000018FE	Motherboard resources
0x00001854-0x00001857	Motherboard resources
0x0000E000-0x0000EFFF	Mobile Intel(R) Processor Family I/O PCI Express Root Port #4 - 9D13
0x0000F000-0x0000F03F	Intel(R) HD Graphics 620
0x0000F040-0x0000F05F	Mobile Intel(R) Processor Family I/O SMBUS - 9D23
0x0000F060-0x0000F07F	Standard SATA AHCI Controller
0x0000F080-0x0000F083	Standard SATA AHCI Controller
0x0000F090-0x0000F097	Standard SATA AHCI Controller
0x0000FF00-0x0000FFFE	Motherboard resources
0x0000FFFF-0x0000FFFF	Motherboard resources
0x0000FFFF-0x0000FFFF	Motherboard resources
0x0000FFFF-0x0000FFFF	Motherboard resources

## Memory Map

Memory Map	Assignment
0xDE000000-0xDEFFFFFF	Intel(R) HD Graphics 620
0xC0000000-0xCFFFFFFF	Intel(R) HD Graphics 620
0xFF000000-0xFFFFFFFF	Legacy device
0xFF000000-0xFFFFFFFF	Motherboard resources
0xFED10000-0xFED17FFF	Motherboard resources
0xFED18000-0xFED18FFF	Motherboard resources
0xFED19000-0xFED19FFF	Motherboard resources
0xE0000000-0xEFFFFFFF	Motherboard resources
0xFED20000-0xFED3FFFF	Motherboard resources
0xFED90000-0xFED93FFF	Motherboard resources
0xFED45000-0xFED8FFFF	Motherboard resources
0xFEE00000-0xFEEFFFFFFF	Motherboard resources
0xDFFE0000-0xDFFFFFFF	Motherboard resources
0xFE029000-0xFE029FFF	Motherboard resources
0xFE028000-0xFE028FFF	Motherboard resources
0xFDAF0000-0xFDAFFFFFFF	Motherboard resources
0xFDAE0000-0xFDAEFFFFF	Motherboard resources
0xFDAC0000-0xFDACFFFFF	Motherboard resources
0xFE034000-0xFE034FFF	Intel(R) Serial IO UART Host Controller - 9D27
0xDFFC0000-0xDFFDFFFFF	Intel(R) Ethernet Connection I219-V
0xFED00000-0xFED003FF	High precision event timer
0xFD000000-0xFDABFFFFF	Motherboard resources
0xFD000000-0xFDABFFFFF	PCI Express Root Complex
0xFDAD0000-0xFDADFFFFF	Motherboard resources

<b>Memory Map</b>	<b>Assignment</b>
0xFDB00000-0xFDFFFFFFFF	Motherboard resources
0xFE000000-0xFE01FFFF	Motherboard resources
0xFE036000-0xFE03BFFF	Motherboard resources
0xFE03D000-0xFE3FFFFFFF	Motherboard resources
0xFE410000-0xFE7FFFFFFF	Motherboard resources
0xFE03C000-0xFE03CFFF	Intel(R) Serial IO I2C Host Controller - 9D60
0xFE030000-0xFE033FFF	High Definition Audio Controller
0xFE400000-0xFE40FFFF	High Definition Audio Controller
0x90000000-0xDFFFFFFF	PCI Express Root Complex
0xFE035000-0xFE035FFF	Intel(R) Management Engine Interface
0xFED40000-0xFED44FFF	Trusted Platform Module 2.0
0xDF130000-0xDF13FFFF	Intel(R) USB 3.0 eXtensible Host Controller - 1.0 (Microsoft)
0xDF14A000-0xDF14A0FF	Mobile Intel(R) Processor Family I/O SMBUS - 9D23
0xDF000000-0xDF01FFFF	Intel(R) I211 Gigabit Network Connection
0xDF000000-0xDF01FFFF	Mobile Intel(R) Processor Family I/O PCI Express Root Port #4 - 9D13
0xDF020000-0xDF023FFF	Intel(R) I211 Gigabit Network Connection
0xDF150000-0xDF150FFF	Mobile Intel(R) Processor Family I/O Thermal subsystem - 9D31
0xDF148000-0xDF149FFF	Standard SATA AHCI Controller
0xDF14D000-0xDF14D0FF	Standard SATA AHCI Controller
0xDF14C000-0xDF14C7FF	Standard SATA AHCI Controller
0xA0000-0xBFFFFF	PCI Express Root Complex
0xC0000-0xC3FFF	PCI Express Root Complex
0xC4000-0xC7FFF	PCI Express Root Complex

<b>Memory Map</b>	<b>Assignment</b>
0xC8000-0xCBFFF	PCI Express Root Complex
0xCC000-0xCFFFF	PCI Express Root Complex
0xD0000-0xD3FFF	PCI Express Root Complex
0xD4000-0xD7FFF	PCI Express Root Complex
0xD8000-0xDBFFF	PCI Express Root Complex
0xDC000-0xDFFFF	PCI Express Root Complex
0xE0000-0xE3FFF	PCI Express Root Complex
0xE4000-0xE7FFF	PCI Express Root Complex
0xE8000-0xEBFFF	PCI Express Root Complex
0xEC000-0xEFFFF	PCI Express Root Complex
0xF0000-0xFFFFF	PCI Express Root Complex

## **Configuring WatchDog Timer**

The I/O port address of the watchdog timer is 2E (hex) and 2F (hex). 2E (hex) is the address port. 2F (hex) is the data port. User must first assign the address of register by writing address value into address port 2E (hex), then write/read data to/from the assigned register through data port 2F (hex).

### **Configuration Sequence**

To program F81866 configuration registers, the following configuration sequence must be followed:

#### **(1) Enter the extended function mode**

To place the chip into the Extended Function Mode, two successive writes of 0x87 must be applied to Extended Function Enable Registers (EFERs, i.e. 2Eh or 4Eh).

#### **(2) Configure the configuration registers**

The chip selects the Logical Device and activates the desired Logical Devices through Extended Function Index Register (EFIR) and Extended Function Data Register (EFDR). The EFIR is located at the same address as the EFER, and the EFDR is located at address (EFIR+1). First, write the Logical Device Number (i.e. 0x07) to the EFIR and then write the number of the desired Logical Device to the EFDR. If accessing the Chip (Global) Control Registers, this step is not required. Secondly, write the address of the desired configuration register within the Logical Device to the EFIR and then write (or read) the desired configuration register through the EFDR.

#### **(3) Exit the extended function mode**

To exit the Extended Function Mode, writing 0xAA to the EFER is required. Once the chip exits the Extended Function Mode, it is in the normal running mode and is ready to enter the configuration mode.

## Code example for watch dog timer

Enable watchdog timer and set timeout interval to 30 seconds.

```
;----- Enter to extended function mode -----  
mov dx, 2eh  
mov al, 87h  
out dx, al  
out dx, al  
;----- Select Logical Device 7 of watchdog timer -----  
mov al, 07h  
out dx, al  
inc dx  
mov al, 07h  
out dx, al  
;----- Enable Watch dog feature -----  
mov al, 030h  
out dx, al  
inc dx  
mov al, 01h  
out dx, al  
;----- Set timeout interval as 30 seconds -----  
dec dx  
mov al, 0F6h  
out dx, al  
inc dx  
mov al, 1Eh  
out dx, al  
;----- Enable Watch PME-----  
dec dx  
mov al, 0FAh  
out dx, al  
inc dx  
in al, dx  
or al, 51h  
out dx, al  
;----- Set second as counting unit and start counting -----  
dec dx  
mov al, 0F5h  
out dx, al  
inc dx  
in al, dx  
and al, 0F7h  
or al, 20h  
out dx, al  
;----- Exit the extended function mode -----  
dec dx  
mov al, 0AAh  
out dx, al
```



## **Flash BIOS Update**

### **I. Prerequisites**

- 1** Prepare a bootable media (e.g. USB storage device) which can boot the system to EFI Shell.
- 2** Download and save the BIOS file (e.g. S1X61PU1.bin) to the storage device.
- 3** Copy AMI flash utility – AFUEFIx64.exe (v5.09.01) into the storage device. The utility and BIOS file should be saved to the same path
- 4** Make sure the target system can first boot to the EFI shell environment.
  - (1) Connect the USB storage device.
  - (2) Turn on the computer and press <ESC> or <DEL> key during boot to enter BIOS Setup.
  - (3) The system will go into the BIOS setup menu.
  - (4) Select [**Boot**] menu and set the USB storage device as the 1st boot device.
  - (5) Press <F4> key to save the configuration and restart the system to boot into EFI Shell environment.

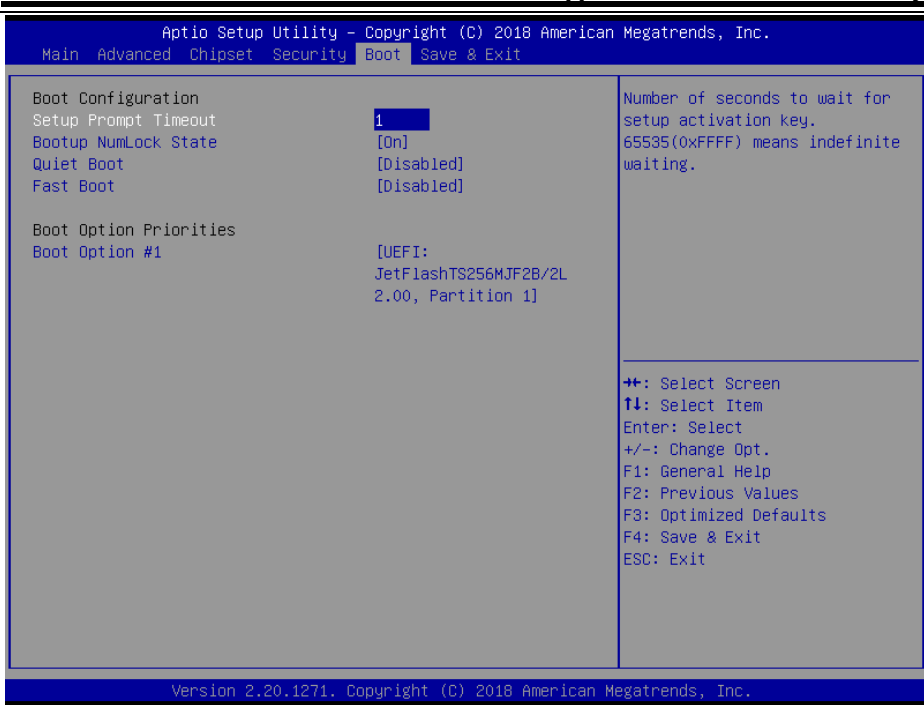

## II. AFUEFIx64 Command for System BIOS Update

AFUEFIx64.efi is the AMI firmware update utility. The command line is shown as below:

**AFUEFIx64 <ROM File Name> [option1] [option2]....**

Users can type “**AFUEFIx64 /?**” to view the definition of each control option. The recommended options for BIOS ROM update include the following parameters:

- /P:** Program main BIOS image.
- /B:** Program Boot Block.
- /N:** Program NVRAM.
- /X:** Don't check ROM ID.

### III. BIOS Update Procedure

1 Boot into EFI Shell and change to the path where you put BIOS image and AFUEFIx64.

```
Shell> fs0:  
fs0:\> cd afuefix64
```

- 2 "AFUEFIx64 S1X61Pxx.bin /p /b /n /x" and press enter to start the flash procedure. (xx means the BIOS revision part, e.g. U1...)
- 3 During the update procedure, you will see the BIOS update process status and its execution percentage. Beware! Do not turn off the system power or reset your computer if the whole procedure are not complete yet, or it may crash the BIOS ROM and the system will be unable to boot up next time.
- 4 After the BIOS update procedure is completed, the following messages will display:

```
fs0:\afuefix64> AFUEFIx64 S1X61PU1.bin /p /b /n /x  
+-----+  
|                AMI Firmware Update Utility v5.12.02.2028                |  
|    Copyright (C) 1985-2019, American Megatrends International LLC.    |  
|    All Rights Reserved. Subject to AMI licensing agreement.            |  
+-----+  
Reading flash ..... done  
- ME Data Size Checking. ok  
- FFS checksums ..... ok  
- Check RomLayout ..... ok  
Erasing Boot Block ..... done  
Updating Boot Block ..... done  
Verifying Boot Block ..... done  
Erasing Main Block ..... done  
Updating Main Block ..... done  
Verifying Main Block ..... done  
Erasing NVRAM Block ..... done  
Updating NVRAM Block ..... done  
Verifying NVRAM Block ..... done  
fs0:\afuefix64>
```

- 5 Restart the system and boot up with the new BIOS configurations.
- 6 The BIOS Update is completed after the system is restarted.

- 7 Reboot the system and verify if the BIOS version shown on the initialization screen has been updated.

